

AFF A400 Systems Installation and Setup Instructions

Prepare and install | Stage 1

Pre-setup

1. Unpack all boxes and inventory contents.
Attention: Customers with specific power requirements must check [Hardware Universe](#) for their configuration options.
 2. Gather information about your storage system by completing the cluster setup worksheets:
[Get started with ONTAP cluster set up](#).
 3. Review the requirements and procedure steps for [Configure ONTAP on a new cluster with System Manager](#).
- Note:** For MetroCluster configurations, use the [MetroCluster installation content](#).

Contents In the box

Cables shown are the most common. See [Hardware Universe](#) for more options.

**25 GbE cable (SFP28)
HA interconnect**
Part numbers X66240-2, 2m;
X66240-5, 5m

**32 Gb FC (SFP+ Op)
FC optical network cable**
Part numbers X66250-2, 2m;
X66250-5, 5m; X66250-15, 15m

**100 GbE cable (QSFP28)
Storage, cluster network,
GbE network, and Ethernet data
(order-dependent)**
Part numbers X66211A-05, 0.5m;
X66211A-1, 1m; X66211A-2, 2m;
X66211A-5, 5m

Additional cables

- Ethernet cables
- micro USB console cable
- Power cables

**RJ-45 cables
Wrench port (e0M/BMC)
(order-dependent)**
Part numbers X5585-R6, 3m;
X6562-R6, 5m

**16 Gb FC or 25GbE cables
Mezzanine cards
(SFPs pre-installed)**
Part number X66250-2-N-C

Cable management tray

Slide rail kit

You provide

Rack space
4U for platform
+2U for each NS224
or DS224C shelf

Screwdriver
Phillips #2

Additional network cables
For connecting your storage system
to your network switch and laptop
or console

Laptop or console
With a USB/serial connection
and access to a Web browser to
configure your storage system

Install storage system in a rack or cabinet

Attention: Airflow through the platform and shelves enters from the front where the bezel or end caps are installed and exhausts out the rear where the ports are located.

1. Install the rail kits for the platform and shelves, as needed, using the instructions included with the kits.
2. Install the platform chassis into the rack or cabinet.
3. Attach the cable management devices to the rear of the platform.
4. Install the bezel on the front of the platform.
5. Install any drive shelves into the rack or cabinet.

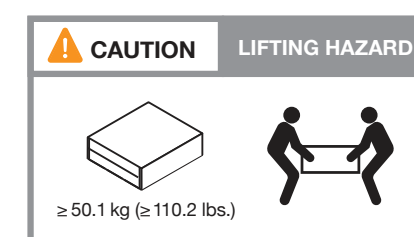
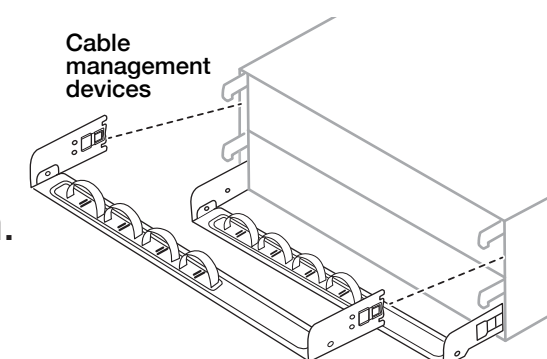

Cable controllers | Stage 2

Attention: Be sure to check the illustration arrow for the proper cable connector pull-tab orientation.
Note: To unplug a cable, gently pull the tab to release the locking mechanism.

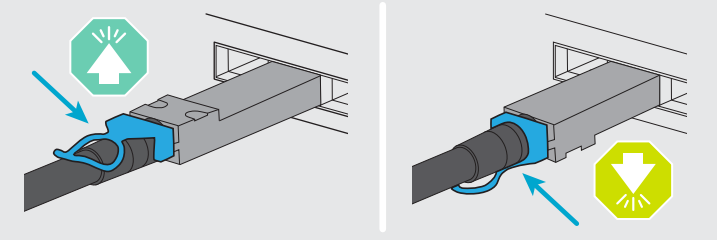

1 Cable the controllers for a switchless or switched cluster

See your network administrator for help connecting to your switches.

Note: If the port labels on the card are not visible, check the card installation orientation (the PCIe connector socket is on the left side of the card slot), and then look for the card, by part number, in the [Hardware Universe](#) for a graphic of the bezel which will show the port labels. The card part number can be found using the `sysconfig -a` command or on the system packing list.



1 Switchless cluster

Connect ports e0c to e0c and ports e0d to e0d.

Switched cluster

Controller A: Connect port e0c to switch 1 and port e0d to switch 2. **Controller B:** Connect port e0c to switch 1 and port e0d to switch 2.



2 Connect ports e0a to e0a and ports e0b to e0b (HA interconnect only).



3 Connect ports to the 100 GbE data network switches (optional, configuration dependent).



4 Connect ports to the FC data network switches (optional, configuration dependent).



5 Connect the Wrench port (e0M/BMC) to the management switches.



6 Connect the mezzanine ports (e0e | 0e through e0h | 0h) to either 25 GbE or 16 Gb FC switches (configuration dependent).

7 Strap the cables to the cable management arms (not shown).

Switchless cluster

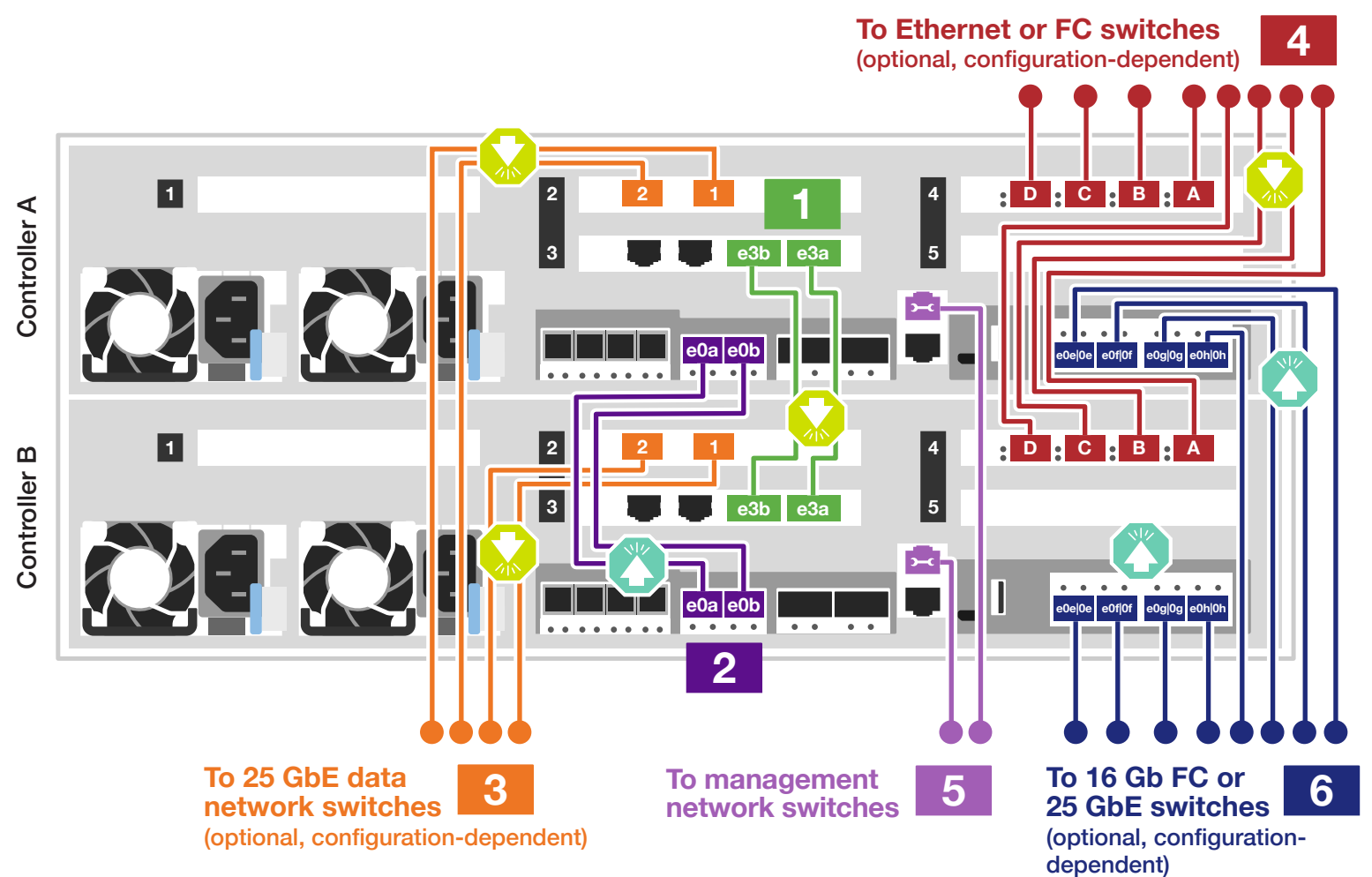

Switched cluster

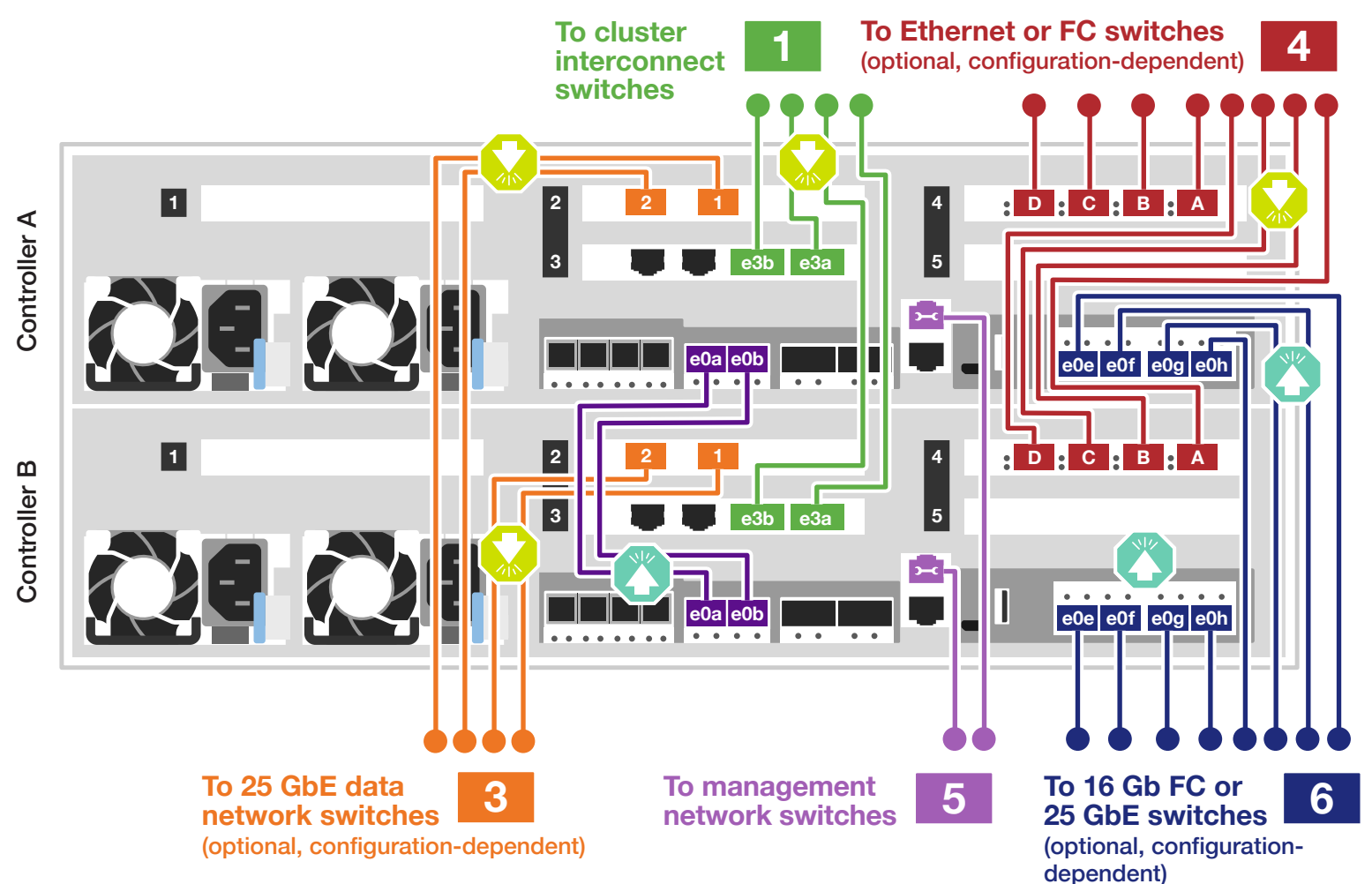

DO NOT plug the power cables into a power source yet.

The storage system will boot as soon as the power cables are plugged into the power source and power supplies.

Cable controllers | Stage 2

Attention: Be sure to check the illustration arrow for the proper cable connector pull-tab orientation.
Note: To unplug a cable, gently pull the tab to release the locking mechanism.

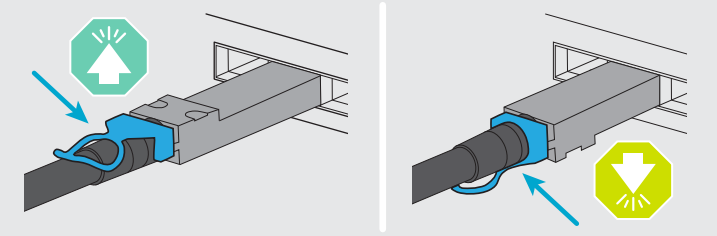

2 Cable storage

Cable to one NS224 shelf



Use the table below to connect your controllers to the NS224 shelf.

		Shelf 1			
		NSM A		NSM B	
		e0a	e0b	e0a	e0b
Controller	A	e0c			
		e0d			
B		e0c			
		e0d			

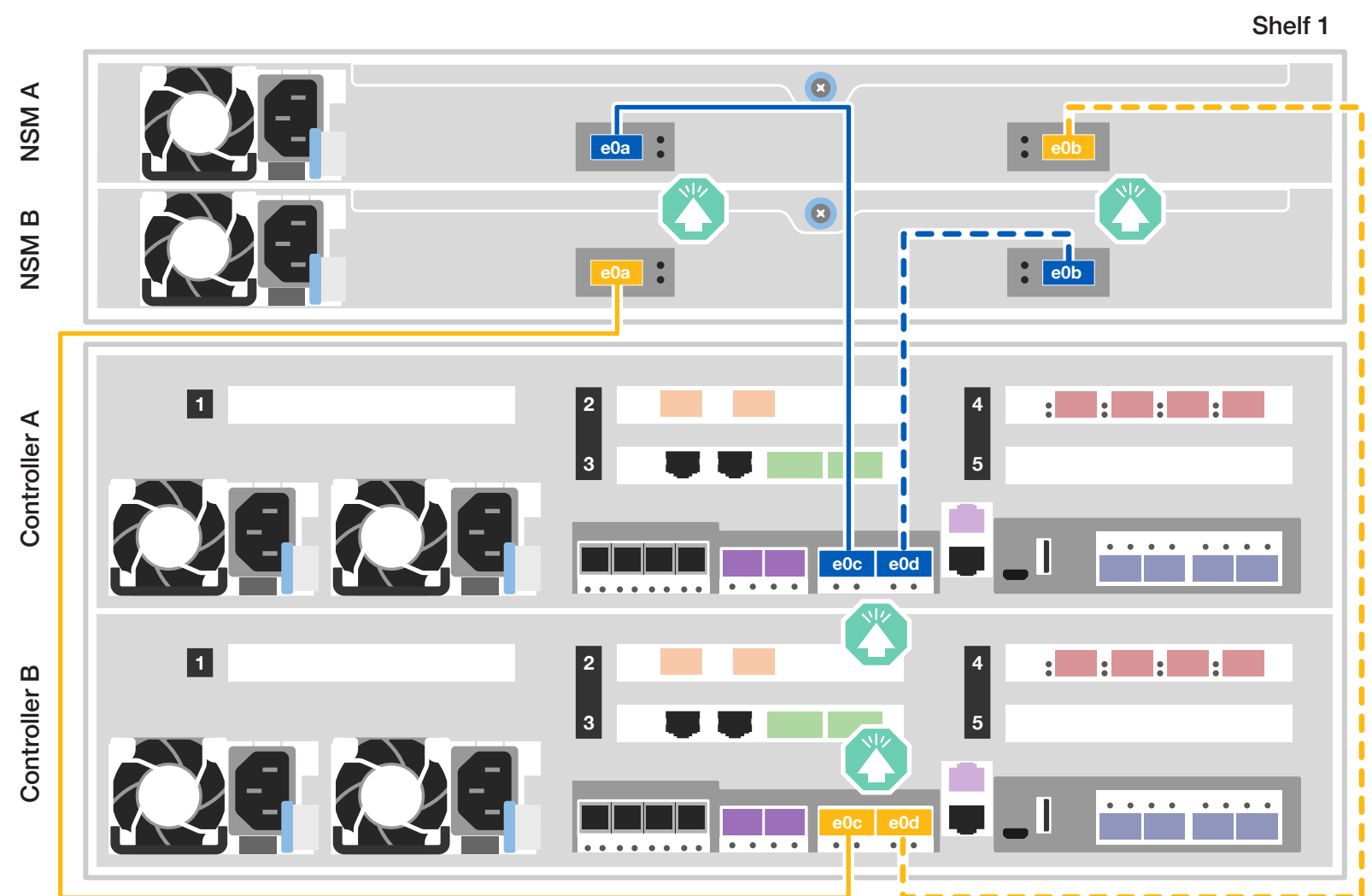

Cable to two NS224 shelves



Use the table below to connect your controllers to the two NS224 shelves.

		Shelf 1				Shelf 2			
		NSM A		NSM B		NSM A		NSM B	
		e0a	e0b	e0a	e0b	e0a	e0b	e0a	e0b
Controller	A	e0c							
		e0d							
	B	e0c							
		e0d							

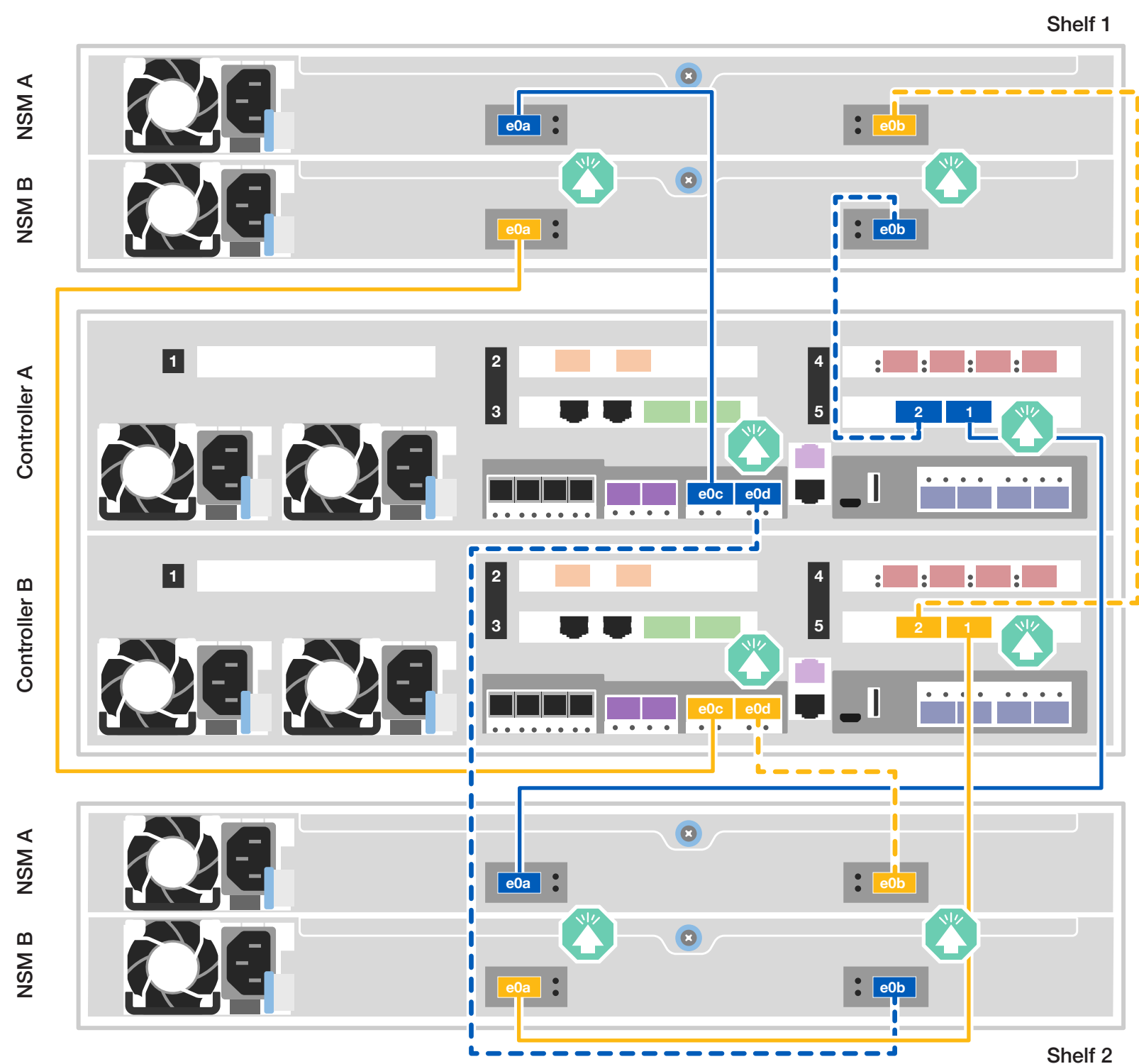

Cable controllers | Stage 2

Attention: Be sure to check the illustration arrow for the proper cable connector pull-tab orientation.
Note: To unplug a cable, gently pull the tab to release the locking mechanism.

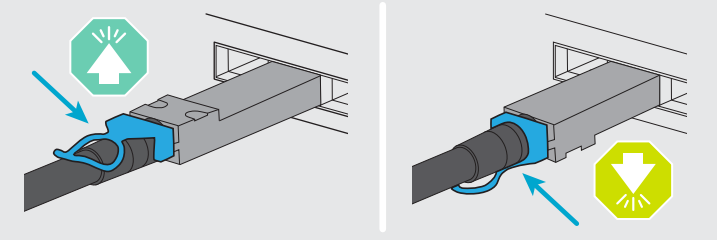

2 Cable storage, continued

Cable to three DS224C shelves

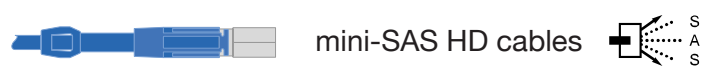

Use the tables below to connect your controllers to three DS224C shelves.

Shelf to shelf

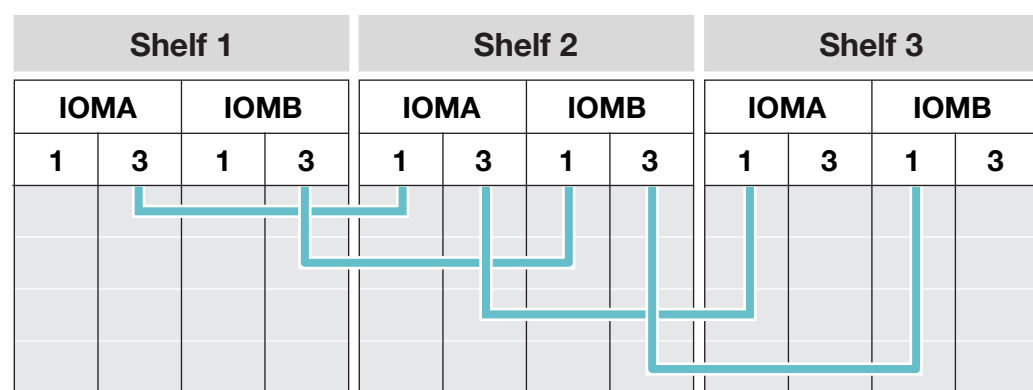

Shelf to controllers

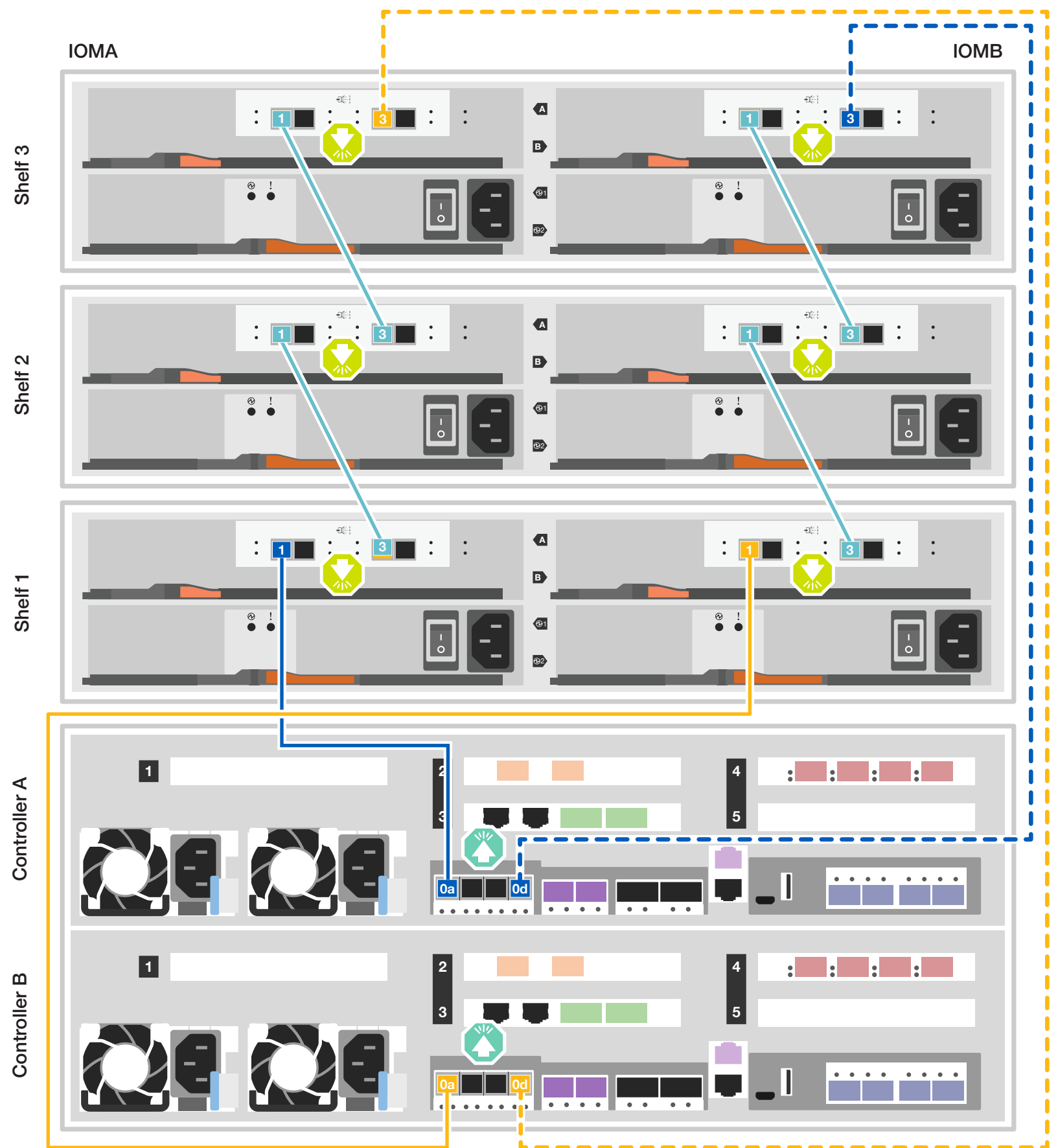
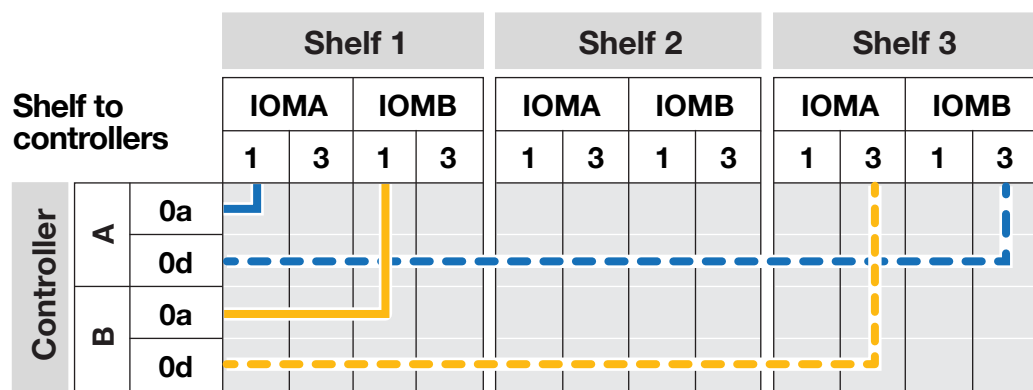

Storage system bring-up | Stage 3

1 Power on the shelves and set shelf IDs

Note: For NS224 drive shelves, shelf IDs are pre-set to 00 and 01. If you want to change the shelf IDs, use the straightened end of a paperclip, or narrow tipped ball point pen to access the shelf ID button behind the faceplate.

1. Plug the power cords into the shelf power supplies, and then connect them to power sources on different circuits.
Note: NS224 shelves have no power switch and will begin to boot.
2. If you need to change the shelf ID's, see the detailed instructions for each shelf type.

[Change a shelf ID - NS224 shelves](#) | [Change a shelf ID - DS224 shelves](#)

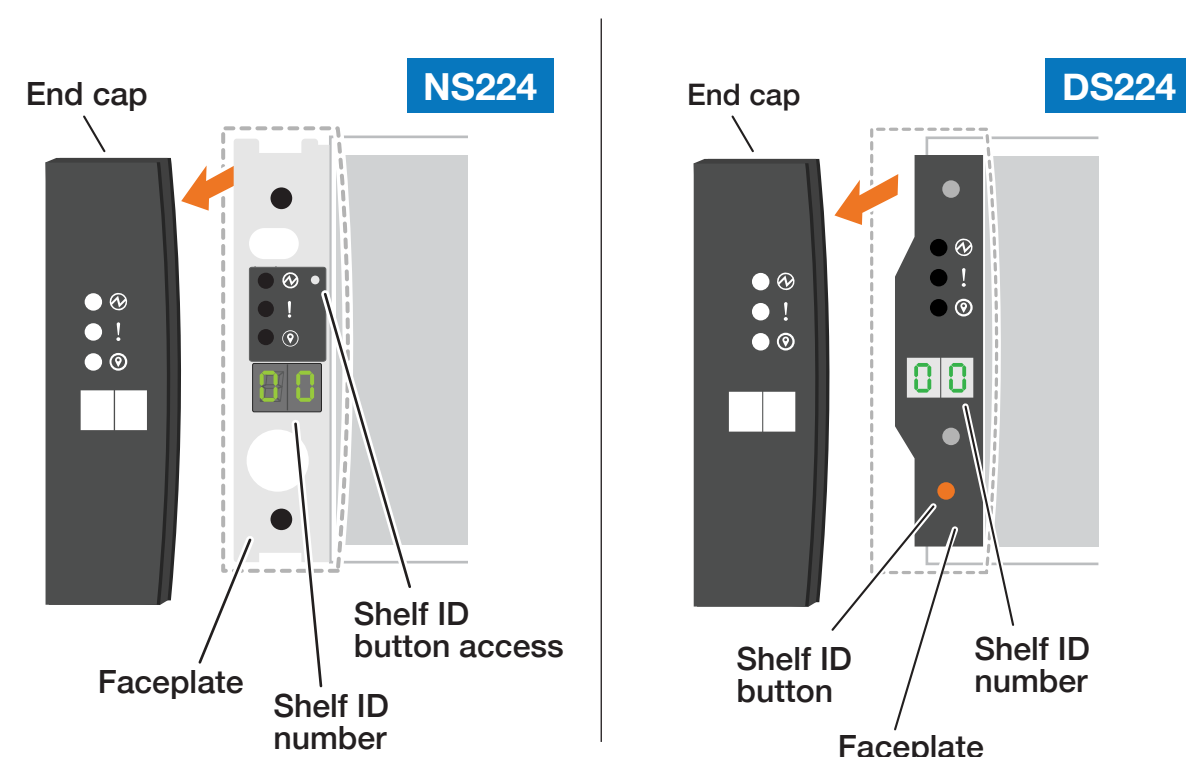

2 Connect the power cables

 Power cables

1. Connect the power cables to each controller's power supplies, and then to power sources on different circuits.
2. Secure the power cables using the securing device on each power supply.

Note: The storage system powers on when plugged into the power sources.

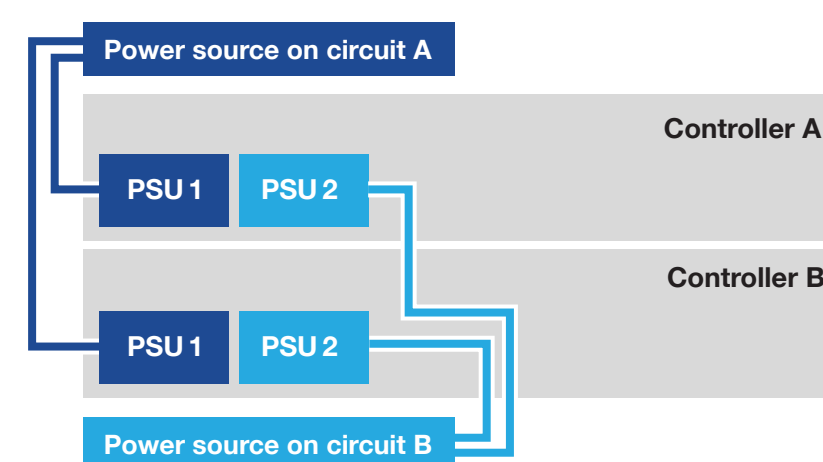

3 Complete the initial cluster setup with network discovery

Note: If your laptop does not support network discovery, see the [Detailed steps](#).

Connect your laptop to the management switch and access the network computers and devices.

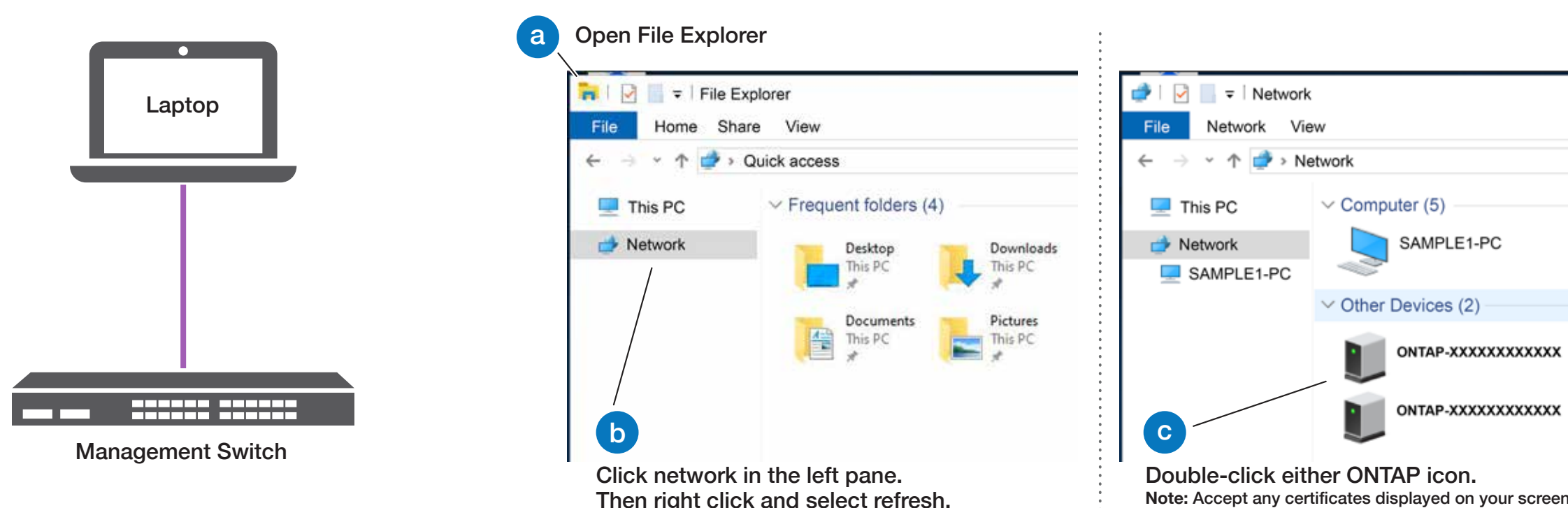

4 Configure your cluster using the [Configure ONTAP on a new cluster with System Manager](#) procedure

5 Complete setup

1. Click...
a) [mysupport.netapp.com](#) b) [Create/log in to your account](#) c) [Register your system](#)
2. [Download and install Active IQ Config Advisor](#), and then run it to verify the health of your storage system.
3. After you have completed the initial configuration, go to the [NetApp ONTAP Resources](#) page for information about configuring additional features in ONTAP.