

AFF A220 or FAS2700 Systems Installation and Setup Instructions

Prepare for installation | Stage 1

Pre-setup

1. Click mysupport.netapp.com and then [create/log in to your account](#), [download and install Active IQ Config Advisor](#), and [register your system](#).
2. Unpack all boxes and inventory contents. For more cable information and part numbers, see the [Hardware Universe](#).
3. Go to the [AFF and FAS System Documentation Center](#) and click AFF A220 and FAS2700 systems, and then Installation and Setup:
 - Download and complete the [Cluster Configuration Worksheet](#).
 - Watch the videos listed under [Setup videos](#).

In the box

Unified configuration (order dependent)

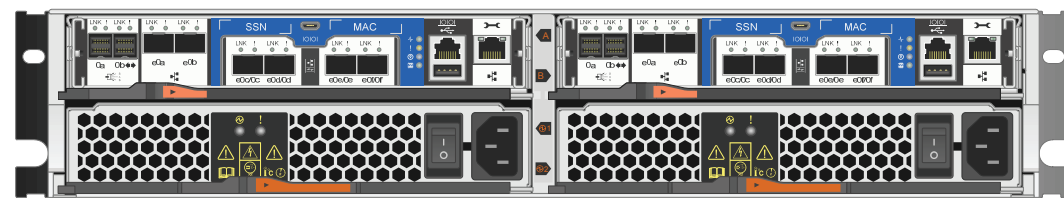

Ethernet configuration (order dependent)

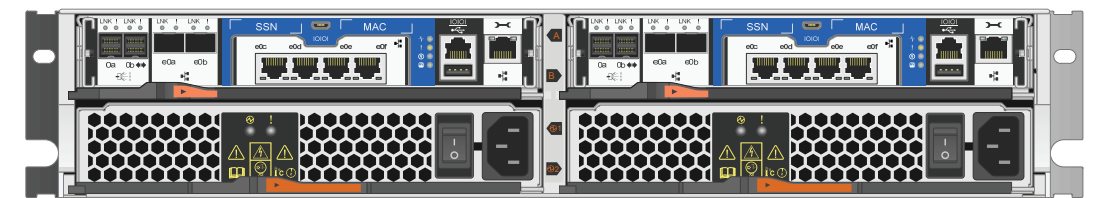

Data and cluster Interconnect cables

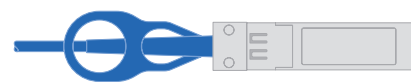

Cluster Interconnect cables
Part number X6566B-05-R6 (112-00297)
or X6566B-2-R6 (112-00299)

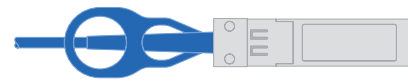

10 GbE network cables (order dependent)
Part number X6566B-2-R6 (112-00299) or
X6566B-3-R6 (112-00300) or X6566B-5-R6 (112-00301)



Optical network cables (order dependent)
Part number X6553-R6 (112-00188) or
X6554-R6 (112-00189) or X6536-R6 (112-00090)



CAT6 RJ-45 cables
Part number X6585-R6 (112-00291)
or X6562-R6 (112-00196)



Storage cables

mini-SAS HD to mini-SAS HD cables
Part number X66030A (112-00435) or X66031A (112-00436)
or X66032A (112-00437) or X66033A (112-00438)

Additional cables



Ethernet cables



Power cables



micro USB console cable

You provide

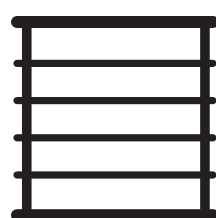

**Rack space
2U per chassis**



**Screwdriver
Phillips #2**

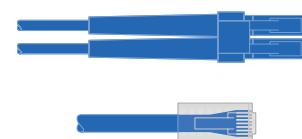

Additional network cables
For connecting your storage system to your
network switch and laptop or console.

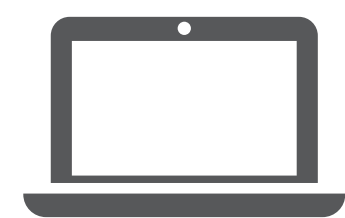

Laptop or console
With USB/serial connect or direct
switch connect and access to a Web browser
to configure your storage system

Install hardware | Stage 2

1 Install system in a rack or cabinet

- Install the rail or telco tray kits, as needed, and then install and secure your system using the instructions included with the kit, or see the 42U 1280 mm [System Cabinet Guide](#) for cabinet installation.
- Attach cable management devices to the back of each controller (as shown).
- Place the bezel on the front of the system.

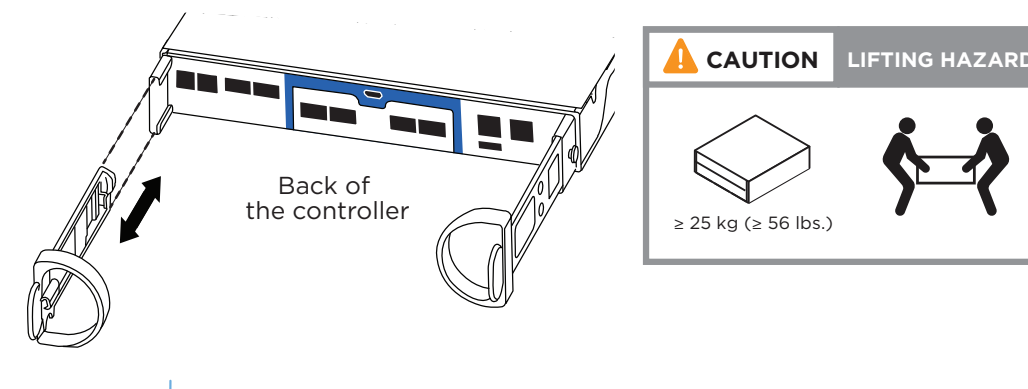

2 Cable controller for switchless or switched cluster

See your network administrator for help connecting to your switches.

Attention: Be sure to check the illustration arrow for the proper cable connector pull-tab orientation.

Note: To unplug a cable, gently pull the tab to release the locking mechanism.

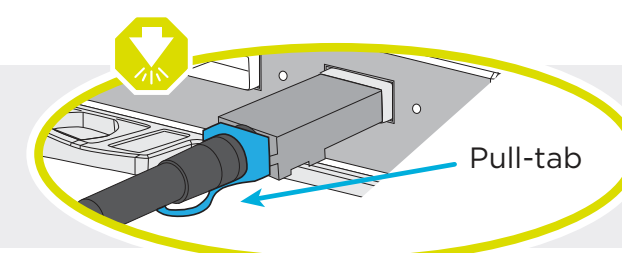

Note: The illustrations below show the Unified configuration system. The cluster and management network cabling remain the same for an Ethernet configuration system. You will be using cables with RJ-45 connectors instead to connect to 10GbE switches.



1 For switchless cluster

Connect port e0a to port e0a and port e0b to port e0b.

For switched cluster

Connect port e0a and port e0b on each controller to the cluster interconnect switches.

2 For Unified configuration



On each controller, connect ports e0c/0c and e0d/0d OR ports e0e/0e and e0f/0f to the FC host network switches.

For Ethernet configuration



On each controller, connect ports e0c and e0e OR ports e0d and e0f to the data network switches.

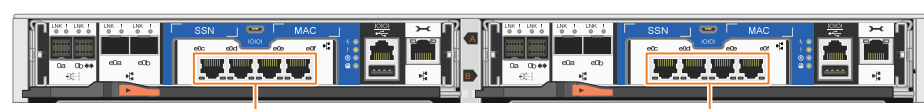

3 Connect the wrench port (e0M + BMC) on both controller modules to the management subnet switches.

4 Strap the cables to the cable management arms. (not shown)

A Switchless cluster

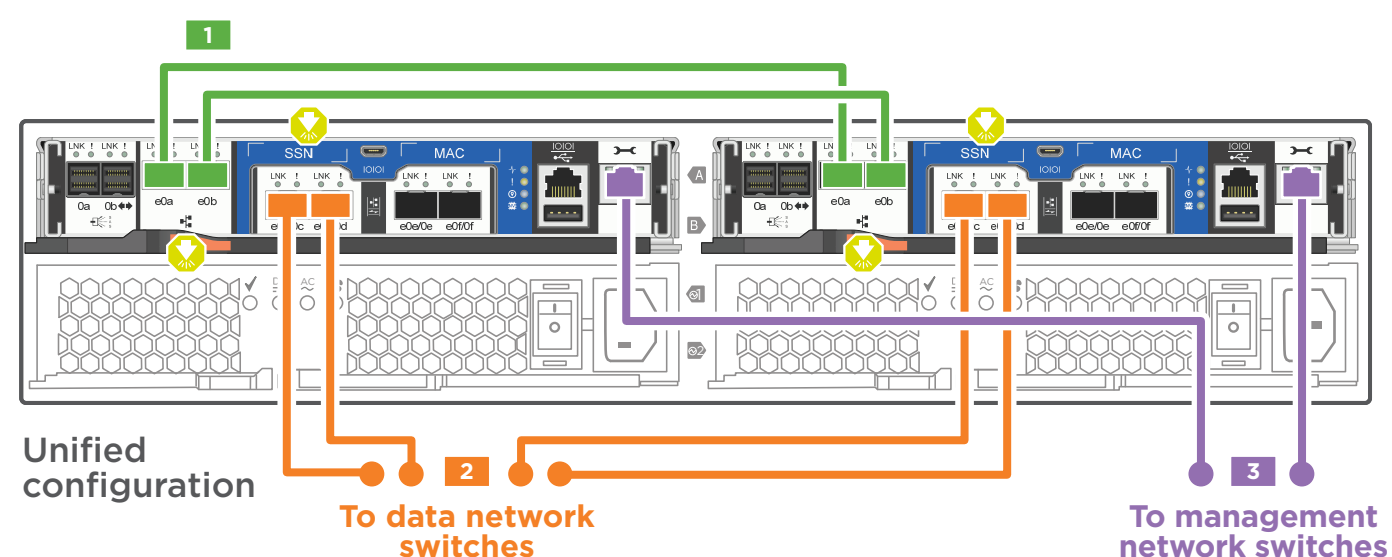

B Switched cluster

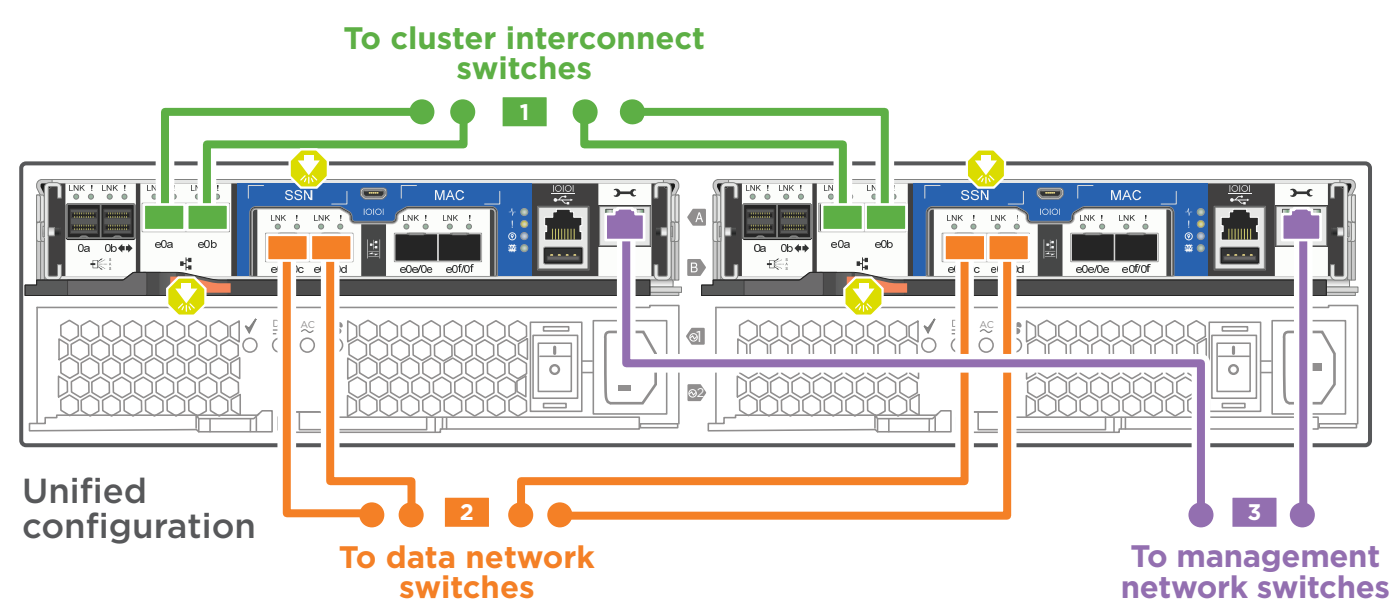

3 Connect both power cords



Connect the power cables to both power supplies.

- Use the retaining clips.
- Connect power cables to different power sources.

DO NOT turn on the power supply switches.

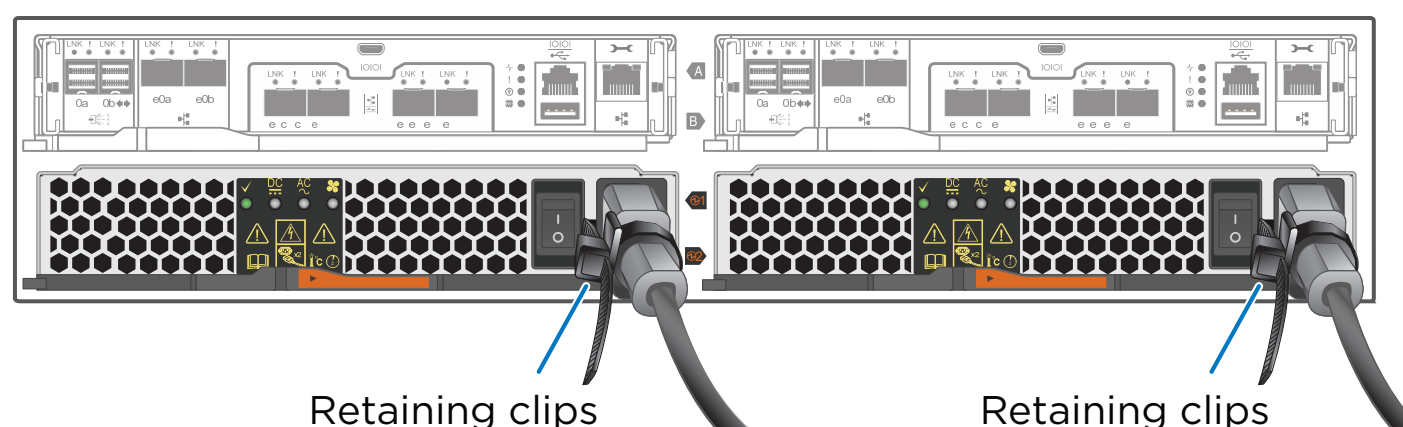

Cable storage | Stage 3

Cabling an AFF A220 or FAS2700 series WITH external storage (DS224C)

Attention: Be sure to check the illustration arrow for the proper cable connector pull-tab orientation.
Note: To unplug a cable, gently pull the tab to release the locking mechanism.

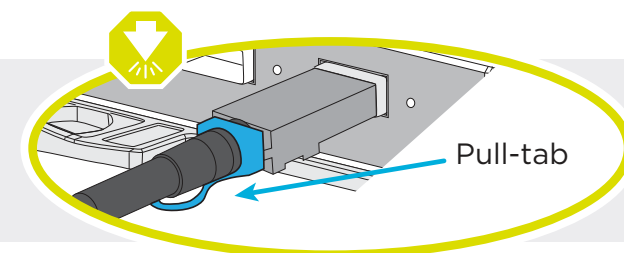

- 1 Connect the shelf-to-shelf ports
- 2 Connect each node to IOM A in the stack
- 3 Connect each node to IOM B in the stack

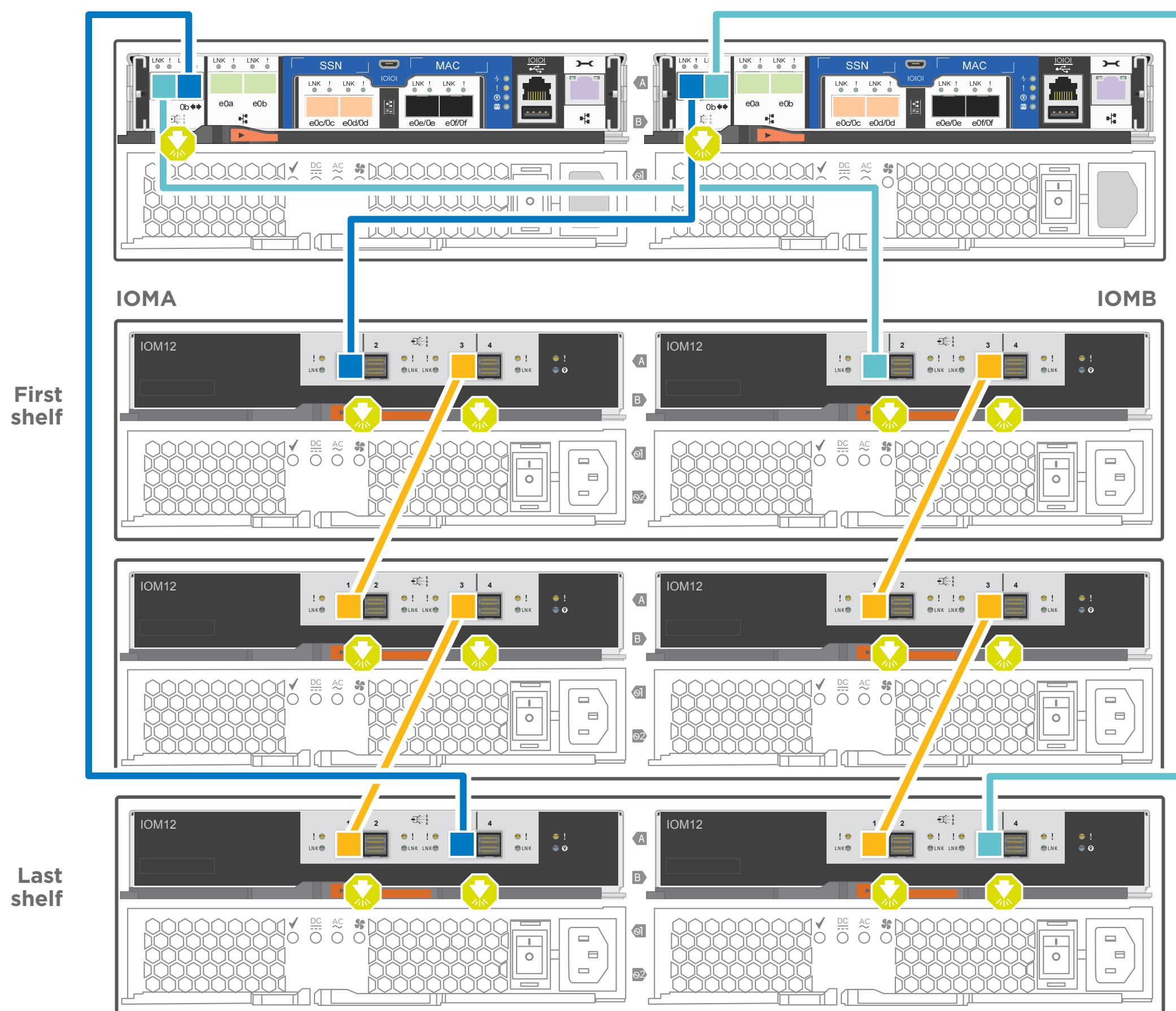

Dual controller system FAS2700 or AFF A220

Complete system setup and configuration | Stage 4

1 If your system has one or more external drive shelves, set the shelf IDs:

1. Power on the drive shelf, and then remove the end cap on the left of the shelf.
2. Press and hold the orange button until the first digit blinks, and then press the button to advance the first digit (0-9) to the desired number. The first digit continues to blink.
3. Press and hold the button until the second digit blinks, and then press the button to advance the second digit (0-9) to the desired number. The first digit stops blinking, and the second digit continues to blink.
4. Press and hold the button until the second digit stops blinking, and then replace the end cap on the shelf.
5. Wait about 10 seconds for both digits to start blinking again and for the LED to illuminate, and then power-cycle the drive shelf to make the shelf ID take effect.
6. Repeat these steps for any remaining drive shelves.

2 Complete initial cluster setup:

Ensure the controller modules are completely cabled and then turn the power supplies.

OPTION A

If your laptop has network discovery enabled:

1. Make sure that your laptop has network discovery enabled. See your laptop's help for more information.
2. Connect your laptop to the Management switch.



3. Go to network devices and double-click either ONTAP icon.



Note: Accept any certificates displayed on your screen.

OPTION B

If your laptop does not have network discovery enabled:

micro USB console cable

- 1 Set the console port on the laptop to 115,200 baud with N-8-1, connect to the micro-USB port on the controller with the console cable.

Ethernet cable

- 2 Connect the laptop to the Management switch and give the laptop a TCP/IP address on the management switch

- 3 Assign an initial node management IP address to one of the nodes. If you have DHCP configured on your management network, record the IP address assigned to the new controllers. Otherwise use Cluster Setup wizard to assign the node management IP address.

- a. Open a console session using PuTTY, a terminal server, or the equivalent for your environment.
- b. Enter the management IP address when prompted by the script.

- 4 Open a browser and enter management IP address. (<https://xxx.xxx.xxx.xxx>)

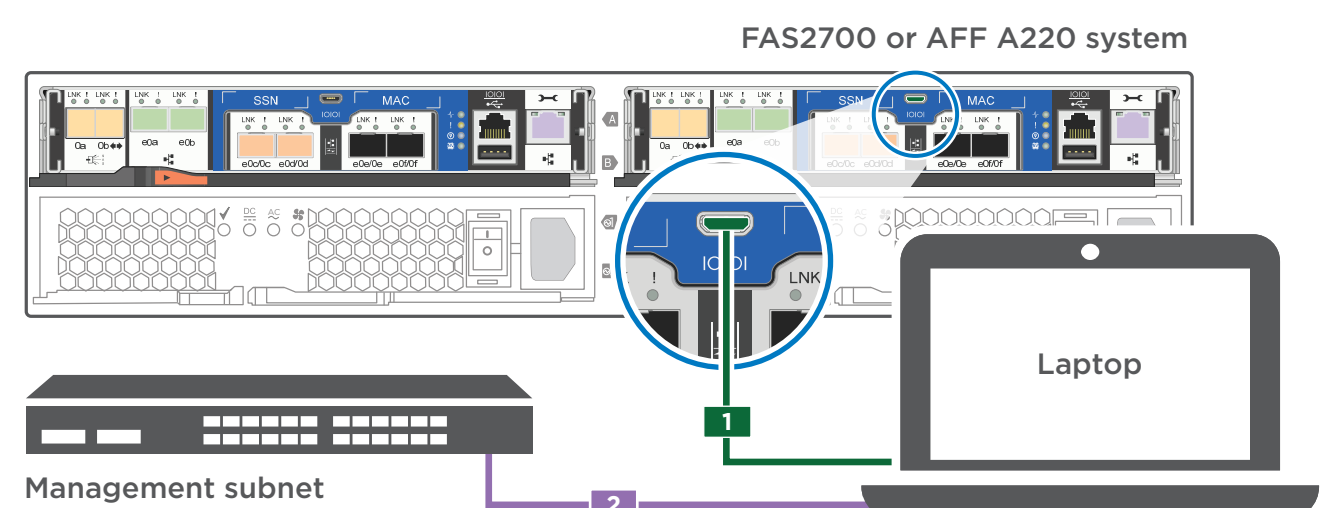

3 Use System Manager Guided Setup to configure your cluster

4 Completing setup

1. Verify the health of your system by running Config Advisor.
2. After you have completed the initial configuration, go to the [NetApp ONTAP Resources](#) page for information about configuring additional features in ONTAP.