



ONTAP® 9

FC Configuration for Windows® Express Guide

March 2021 | 215-11173_2021-03_en-us
doccomments@netapp.com

Updated for ONTAP 9.8

 **NetApp®**

Contents

- Deciding whether to use the FC Configuration for Windows Express Guide..... 3**

- FC configuration workflow..... 4**
 - Verifying that the FC configuration is supported 4
 - Completing the FC configuration worksheet.....5
 - Installing the HBA utility from the HBA vendor..... 6
 - Updating the HBA driver, firmware, and BIOS.....7
 - Recording the WWPN for each host FC port..... 7
 - Installing Windows Unified Host Utilities.....8
 - Creating an aggregate..... 9
 - Deciding where to provision the volume..... 9
 - Verifying that the FC service is running on an existing SVM..... 10
 - Creating a LUN.....10
 - Configuring FC on an existing SVM..... 11
 - Creating a new SVM.....12
 - Zoning the FC switches by the host and LIF WWPNs..... 14
 - Discovering new disks..... 15
 - Initializing and formatting the LUN..... 16
 - Verifying that the host can write to and read from the LUN..... 16

- Where to find additional information..... 17**

- Copyright, trademark, and machine translation..... 18**
 - Copyright..... 18
 - Trademark..... 18
 - Machine translation..... 18

Deciding whether to use the FC Configuration for Windows Express Guide

This guide describes how to quickly set up the FC service on a storage virtual machine (SVM), provision a LUN, and make the LUN available using an FC HBA on a Windows host computer.

This guide is based on the following assumptions:

- You want to use best practices, not explore every available option.
- You do not want to read a lot of conceptual background.
- You want to use System Manager, not the ONTAP command-line interface or an automated scripting tool.

[Cluster management using System Manager](#)

- You want to use the *legacy* OnCommand System Manager UI for ONTAP 9.7 and earlier releases, not the ONTAP System Manager UI for ONTAP 9.7 and later.

[ONTAP System Manager documentation](#)

- You are using traditional FC HBAs and switches.
This guide does not cover FCoE.
- You have at least two FC target ports available on each node in the cluster.
Onboard FC and UTA2 (also called "CNA") ports, as well as some adapters are configurable. Configuring those ports is done in the ONTAP CLI and is not covered in this guide.
- You are not configuring FC SAN boot.
- You are not using virtual Fibre Channel (VFC) with Hyper-V or ESX guests.

If these assumptions are not correct for your situation, you should see the following resources:

- *[SAN administration](#)*
- *[SAN configuration](#)*
- *[NetApp Documentation: Host Utilities \(current releases\)](#)* for your version of Windows Unified Host Utilities
- *[NetApp Documentation: OnCommand Workflow Automation \(current releases\)](#)*
OnCommand Workflow Automation enables you to run prepackaged workflows that automate management tasks such as the workflows described in Express Guides.

FC configuration workflow

When you make storage available to a host using FC, you provision a volume and LUN on the storage virtual machine (SVM), and then connect to the LUN from the host.

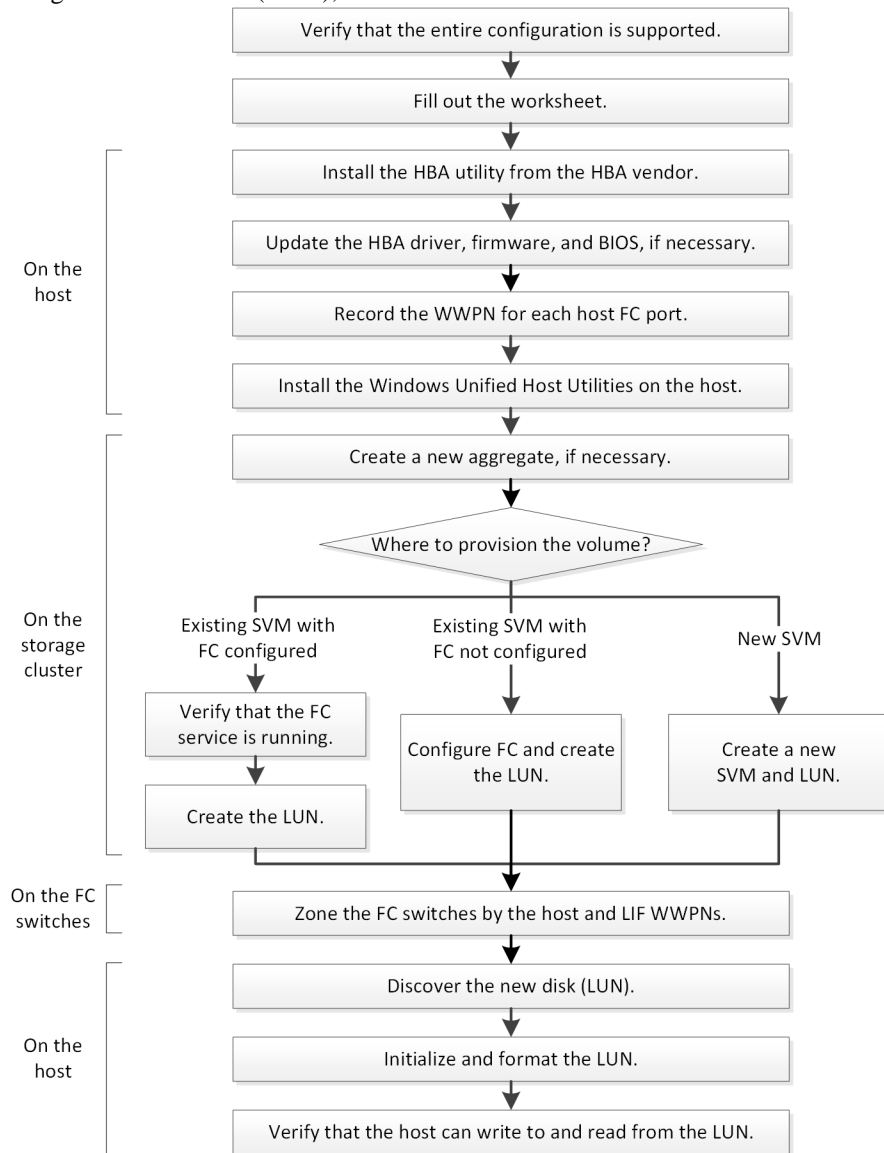

Verifying that the FC configuration is supported

For reliable operation, you must verify that the entire FC configuration is supported.

Steps

1. Go to the Interoperability Matrix to verify that you have a supported combination of the following components:
 - ONTAP software
 - Host computer CPU architecture (for standard rack servers)
 - Specific processor blade model (for blade servers)
 - FC host bus adapter (HBA) model and driver, firmware, and BIOS versions

- Storage protocol (FC)
 - Windows operating system version
 - Windows Unified Host Utilities
2. Click the configuration name for the selected configuration.
 Details for that configuration are displayed in the Configuration Details window.
 3. Review the information in the following tabs:
 - Notes
 Lists important alerts and information that are specific to your configuration.
 Review the alerts to identify the hotfixes that are required for your operating system.
 - Policies and Guidelines
 Provides general guidelines for all SAN configurations.

Completing the FC configuration worksheet

You require FC initiator and target WWPNs and storage configuration information to perform FC configuration tasks.

FC host WWPNs

Port	WWPN
Initiator (host) port connected to FC switch 1	
Initiator (host) port connected to FC switch 2	

FC target WWPNs

You require two FC data LIFs for each node in the cluster. The WWPNs are assigned by ONTAP when you create the LIFs as part of creating the storage virtual machine (SVM).

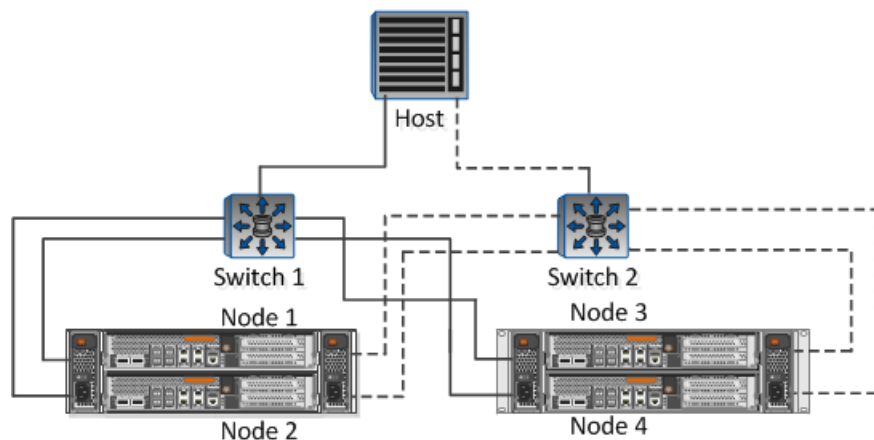

LIF	WWPN
Node 1 LIF with port connected to FC switch 1	
Node 2 LIF with port connected to FC switch 1	
Node 3 LIF with port connected to FC switch 1	
Node 4 LIF with port connected to FC switch 1	
Node 1 LIF with port connected to FC switch 2	
Node 2 LIF with port connected to FC switch 2	

LIF	WWPN
Node 3 LIF with port connected to FC switch 2	
Node 4 LIF with port connected to FC switch 2	

Storage configuration

If the aggregate and SVM are already created, record their names here; otherwise, you can create them as required:

Node to own LUN	
Aggregate name	
SVM name	

LUN information

LUN size	
Host operating system	
LUN name (optional)	
LUN description (optional)	

SVM information

If you are not using an existing SVM, you require the following information to create a new one:

SVM name	
SVM IPspace	
Aggregate for SVM root volume	
SVM user name (optional)	
SVM password (optional)	
SVM management LIF (optional)	Subnet:
	IP address:
	Network mask:
	Gateway:
	Home node:
	Home port:

Installing the HBA utility from the HBA vendor

The HBA utility enables you to view the worldwide port name (WWPN) of each FC port. The utility is also useful for troubleshooting FC issues.

About this task

Each HBA vendor offers an HBA utility for their FC HBAs. You must download the correct version for your host operating system and CPU.

The following is a partial list of HBA utilities:

- Emulex HBA Manager, formerly known as OneCommand Manager, for Emulex HBAs

- QLogic QConvergeConsole for QLogic HBAs

Steps

1. Download the appropriate utility from your HBA vendor's web site.
2. Run the installation program and follow the prompts to complete the installation.

Related information

[Broadcom \(Emulex\) Support Documents and Downloads](#)

[Emulex HBA Manager](#)

[QLogic: NetApp Downloads](#)

Updating the HBA driver, firmware, and BIOS

If the FC host bus adapters (HBAs) in the Windows host are not running supported driver, firmware, and BIOS versions, you must update them.

Before you begin

You must have identified the supported driver, firmware, and BIOS versions for your configuration from the Interoperability Matrix tool.

[NetApp Interoperability Matrix Tool](#)

About this task

Drivers, firmware, BIOS, and HBA utilities are provided by the HBA vendors.

Steps

1. List the installed HBA driver, firmware, and BIOS versions by using the HBA utility from your HBA vendor.
2. Download and install the new driver, firmware, and BIOS as needed from the HBA vendor's support site.

Installation instructions and any required installation utilities are available with the download.

Recording the WWPN for each host FC port

The worldwide port name (WWPN) is required to zone the FC switches and to create the igroups that allow the host to access its LUN.

Before you begin

You must have installed the vendor's HBA utility for the HBAs in your host and verified HBAs are running supported driver, firmware, and BIOS versions for your configuration.

About this task

The WWPN is used for all configuration. You do not have to record the worldwide node name (WWNN).

Steps

1. Run the HBA utility for your FC HBA type.
2. Select the HBA.
3. Record the WWPN of each port.

The following example shows Emulex HBA Manager, formerly known as OneCommand Manager.

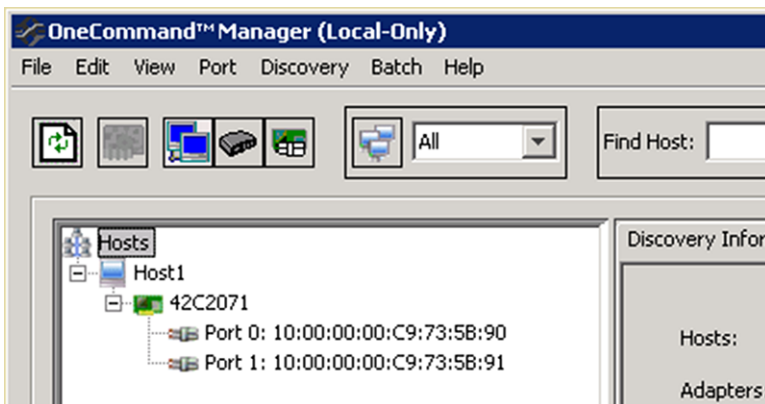

Other utilities, such as QLogic QConvergeConsole, provide the equivalent information.

4. Repeat the previous step for each FC HBA in the host.

Installing Windows Unified Host Utilities

Windows Unified Host Utilities includes an installation program that sets the required Windows registry and HBA parameters so that the Windows host correctly handles the storage system behaviors for NetApp ONTAP and E-Series platforms.

Before you begin

You must have completed the following tasks:

- Check the supported configuration in the Interoperability Matrix
[NetApp Interoperability Matrix Tool](#)
- Identified any required Windows hotfixes from the Interoperability Matrix
[NetApp Interoperability Matrix Tool](#)
- Add the FCP license and start the target service
- Verify your cabling

See the *SAN Configuration Guide* for your version of ONTAP or the *Hardware Cabling Guide* for your E-Series storage system on the NetApp Support Site for detailed cabling and configuration information.

About this task

You must specify whether to include multipathing support when you install the Windows Unified Host Utilities software package. Choose MPIO if you have more than one path from the Windows host or virtual machine to the storage system. Choose no MPIO only if you are using a single path to the storage system.

Note: The MPIO selection is not available for Windows XP and Windows Vista systems; multipath I/O is not supported on these guest operating systems.

For Hyper-V guests, raw (pass-through) disks do not appear in the guest OS if you choose multipathing support. You can either use raw disks, or you can use MPIO, but you cannot use both in the guest OS.

Detailed installation information is available in the *Windows Unified Host Installation Guide* on the NetApp Support Site.

[NetApp Support](#)

Steps

1. Download the appropriate version of the Windows Unified Host Utilities from the NetApp Support Site.

NetApp Support

2. Run the executable file and follow the instructions on the screen.
3. Reboot the Windows host when prompted.

Creating an aggregate

If you do not want to use an existing aggregate, you can create a new aggregate to provide physical storage to the volume which you are provisioning.

Steps

1. Enter the URL **https://IP-address-of-cluster-management-LIF** in a web browser and log in to System Manager using your cluster administrator credential.
2. Navigate to the **Aggregates** window.
3. Click **Create**.
4. Follow the instructions on the screen to create the aggregate using the default RAID-DP configuration, and then click **Create**.

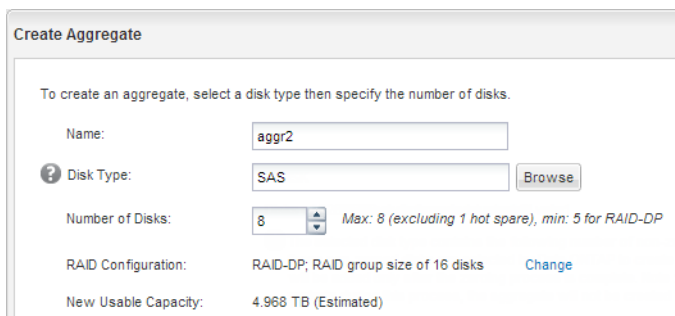

The screenshot shows a 'Create Aggregate' window with the following fields and values:

- Name: aggr2
- Disk Type: SAS (with a 'Browse' button)
- Number of Disks: 8 (with a range of 'Max: 8 (excluding 1 hot spare), min: 5 for RAID-DP')
- RAID Configuration: RAID-DP; RAID group size of 16 disks (with a 'Change' link)
- New Usable Capacity: 4.968 TB (Estimated)

Result

The aggregate is created with the specified configuration and added to the list of aggregates in the Aggregates window.

Deciding where to provision the volume

Before you provision a volume to contain your LUNs, you need to decide whether to add the volume to an existing storage virtual machine (SVM) or to create a new SVM for the volume. You might also need to configure FC on an existing SVM.

About this task

If an existing SVM is already configured with the needed protocols and has LIFs that can be accessed from the host, it is easier to use the existing SVM.

You can create a new SVM to separate data or administration from other users of the storage cluster. There is no advantage to using separate SVMs just to separate different protocols.

Choices

- If you want to provision volumes on an SVM that is already configured for FC, you must verify that the FC service is running and then create a LUN on the SVM.

Verifying that the FC service is running on an existing SVM on page 10

Creating a LUN on page 10

- If you want to provision volumes on an existing SVM that has FC enabled but not configured, configure iSCSI on the existing SVM.

Configuring FC on an existing SVM

This is the case when you followed another Express Guide to create the SVM while configuring a different protocol.

- If you want to provision volumes on a new SVM, create the SVM.

[Creating a new SVM](#)

Verifying that the FC service is running on an existing SVM

If you choose to use an existing storage virtual machine (SVM), you must verify that the FC service is running on the SVM by using ONTAP System Manager. You must also verify that FC logical interfaces (LIFs) are already created.

Before you begin

You must have selected an existing SVM on which you plan to create a new LUN.

Steps

1. Navigate to the **SVMs** window.
2. Select the required SVM.
3. Click the **SVM Settings** tab.
4. In the **Protocols** pane, click **FC/FCoE**.
5. Verify that the FC service is running.

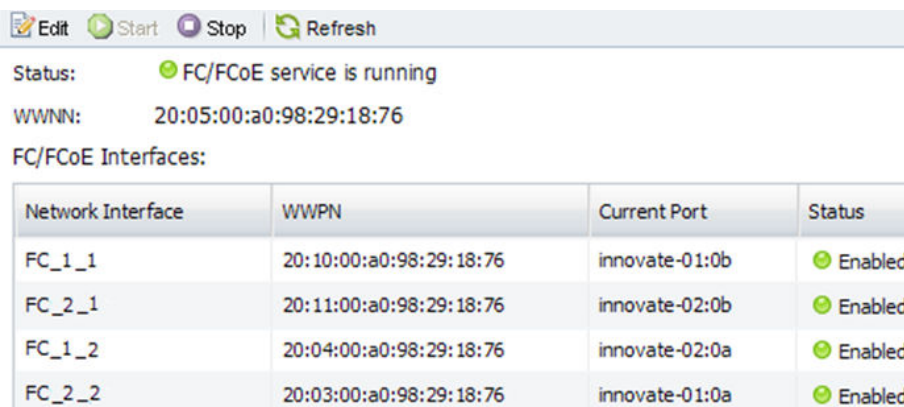

If the FC service is not running, start the FC service or create a new SVM.

6. Verify that there are at least two FC LIFs listed for each node.

If there are fewer than two FC LIFs per node, update the FC configuration on the SVM or create a new SVM for FC.

Creating a LUN

You use the Create LUN wizard to create a LUN. The wizard also creates the igroup and maps the LUN to the igroup, which enables the specified host to access the LUN.

Before you begin

- There must be an aggregate with enough free space to contain the LUN.
- There must be a storage virtual machine (SVM) with the FC protocol enabled and the appropriate logical interfaces (LIFs) created.
- You must have recorded the worldwide port names (WWPNs) of the host FC ports.

About this task

If your organization has a naming convention, you should use names for the LUN, volume, and so on that fit your convention. Otherwise, you should accept the default names.

Steps

1. Navigate to the **LUNs** window.
2. Click **Create**.
3. Browse and select an SVM in which you want to create the LUNs.
The Create LUN Wizard is displayed.
4. On the **General Properties** page, select the LUN type **Windows 2008 or later** for LUNs used directly by the Windows host, or select **Hyper-V** for LUNs containing virtual hard disks (VHDs) for Hyper-V virtual machines.
Leave the **Thin Provisioned** check box unselected.



You can specify the size of the LUN. Storage will be optimized according to the type selected.

Type: ▾

Size: ▾

Thin Provisioned

5. On the **LUN Container** page, select an existing FlexVol volume.
You must ensure that there is enough space in the volume. If sufficient space is not available in the existing volumes, you can create a new volume.
6. On the **Initiators Mapping** page, click **Add Initiator Group**, enter the required information on the **General** tab, and then on the **Initiators** tab, enter all the WWPNs of the host FC ports that you recorded.
7. Confirm the details, and then click **Finish** to complete the wizard.

Related information

[System administration](#)

Configuring FC on an existing SVM

You can configure FC on an existing storage virtual machine (SVM) and create a LUN and its containing volume with a single wizard. The FC protocol must already be enabled but not configured on the SVM. This information is intended for SVMs for which you are configuring multiple protocols, but have not yet configured FC.

Before you begin

Your FC fabric must be configured and the desired physical ports must be connected to the fabric.

Steps

1. Navigate to the **SVMs** window.
2. Select the SVM that you want to configure.
3. In the SVM **Details** pane, verify that **FC/FCoE** is displayed with a gray background, which indicates that the protocol is enabled but not fully configured.
If **FC/FCoE** is displayed with a green background, the SVM is already configured.



4. Click the **FC/FCoE** protocol link with the gray background.
The Configure FC/FCoE Protocol window is displayed.
5. Configure the FC service and LIFs from the **Configure FC/FCoE protocol** page:
 - a. Select the **Configure Data LIFs for FC** check box.

- b. Enter **2** in the **LIFs per node** field.
Two LIFs are required for each node, to ensure availability and data mobility.
- c. In the **Provision a LUN for FCP storage** area, enter the desired LUN size, host type, and WWPNs of the host initiators.
- d. Click **Submit & Close**.

Configure FC/FCoE protocol

Configure LIFs to access the data using FC/FCoE protocol

Data Interface (LIF) Configuration

Both FC and FCoE enabled hardware found. Click on the appropriate checkbox to configure the FC and/or FCoE LIFs.

Configure Data LIFs for FC

LIFs per node:
(Minimum: 1, Maximum: 2)

Provision a Lun for FCP storage (Optional)

Lun Size: GB

LUN OS Type:

Host Initiator:

Review or Edit the Interface Association

Configure Data LIFs for FCoE

- 6. Review the **Summary** page, record the LIF information, and then click **OK**.

Creating a new SVM

The storage virtual machine (SVM) provides the FC target through which a host accesses LUNs. When you create the SVM, you also create logical interfaces (LIFs) and the LUN and its containing volume. You can create an SVM to separate the data and administration functions of a user from those of the other users in a cluster.

Before you begin

- Your FC fabric must be configured and the desired physical ports must be connected to the fabric.

Steps

1. Navigate to the **SVMs** window.
2. Click **Create**.
3. In the **Storage Virtual Machine (SVM) Setup** window, create the SVM:

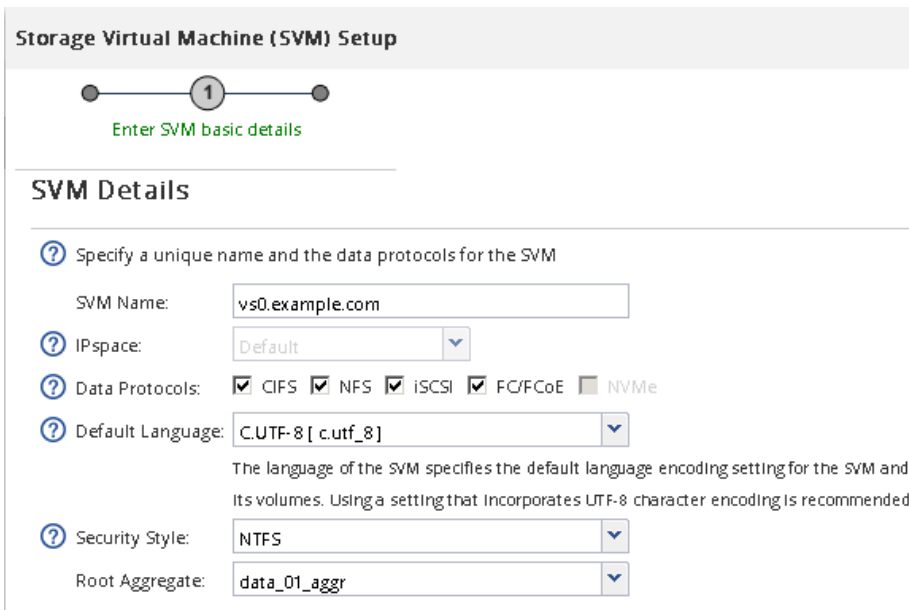

- a. Specify a unique name for the SVM.
The name must either be a fully qualified domain name (FQDN) or follow another convention that ensures unique names across a cluster.
 - b. Select the IPspace that the SVM will belong to.
If the cluster does not use multiple IPspaces, the "Default" IPspace is used.
 - c. Keep the default volume type selection.
Only FlexVol volumes are supported with SAN protocols.
 - d. Select all of the protocols that you have licenses for and that you might use on the SVM, even if you do not want to configure all of the protocols immediately.
Selecting both NFS and CIFS when you create the SVM enables these two protocols to share the same LIFs. Adding these protocols later does not allow them to share LIFs.
If CIFS is one of the protocols you selected, then the security style is set to NTFS. Otherwise, the security style is set to UNIX.
 - e. Keep the default language setting C.UTF-8.
 - f. Select the desired root aggregate to contain the SVM root volume.
The aggregate for the data volume is selected separately in a later step.
 - g. Click **Submit & Continue**.
The SVM is created, but protocols are not yet configured.
4. If the **Configure CIFS/NFS protocol** page appears because you enabled CIFS or NFS, click **Skip** and then configure CIFS or NFS later.
 5. If the **Configure iSCSI protocol** page appears because you enabled iSCSI, click **Skip** and then configure iSCSI later.
 6. Configure the FC service and create LIFs, and the LUN and its containing volume from the **Configure FC/FCoE protocol** page:
 - a. Select the **Configure Data LIFs for FC** check box.
 - b. Enter 2 in the **LIFs per node** field.
Two LIFs are required for each node to ensure availability and data mobility.
 - c. In the **Provision a LUN for FCP storage** area, enter the desired LUN size, host type, and WWPNs of the host initiators.
 - d. Click **Submit & Continue**.

Configure FC/FCoE protocol

? Configure LIFs to access the data using FC/FCoE protocol

Data Interface (LIF) Configuration

Both FC and FCoE enabled hardware found. Click on the appropriate checkbox to configure the FC and/or FCoE LIFs.

Configure Data LIFs for FC

LIFs per node:
(Minimum: 1, Maximum: 2)

Provision a Lun for FCP storage (Optional)

Lun Size: GB

LUN OS Type:

Host Initiator:

Review or Edit the Interface Association

Configure Data LIFs for FCoE

7. When the **SVM Administration** appears, configure or defer configuring a separate administrator for this SVM:
 - Click **Skip** and configure an administrator later if desired.
 - Enter the requested information, and then click **Submit & Continue**.
8. Review the **Summary** page, record the LIF information, and then click **OK**.

Zoning the FC switches by the host and LIF WWPNs

Zoning the FC switches enables the hosts to connect to the storage and limits the number of paths. You zone the switches using the management interface of the switches.

Before you begin

- You must have administrator credentials for the switches.
- You must know the WWPN of each host initiator port and of each FC LIF for the storage virtual machine (SVM) in which you created the LUN.

About this task

For details about zoning your switches, see the switch vendor's documentation.

You must zone by WWPN, not by physical port. Each initiator port must be in a separate zone with all of its corresponding target ports.

LUNs are mapped to a subset of the initiators in the igroup to limit the number of paths from the host to the LUN.

- By default, ONTAP uses Selective LUN Map to make the LUN accessible only through paths on the node owning the LUN and its HA partner.
- You still must zone all of the FC LIFs on every node for LUN mobility in case the LUN is moved to another node in the cluster.
- When moving a volume or a LUN, you must modify the Selective LUN Map reporting-nodes list before moving.

The following illustration shows a host connected to a four-node cluster. There are two zones, one zone indicated by the solid lines and one zone indicated by the dashed lines. Each zone contains one initiator from the host and a LIF from each storage node.

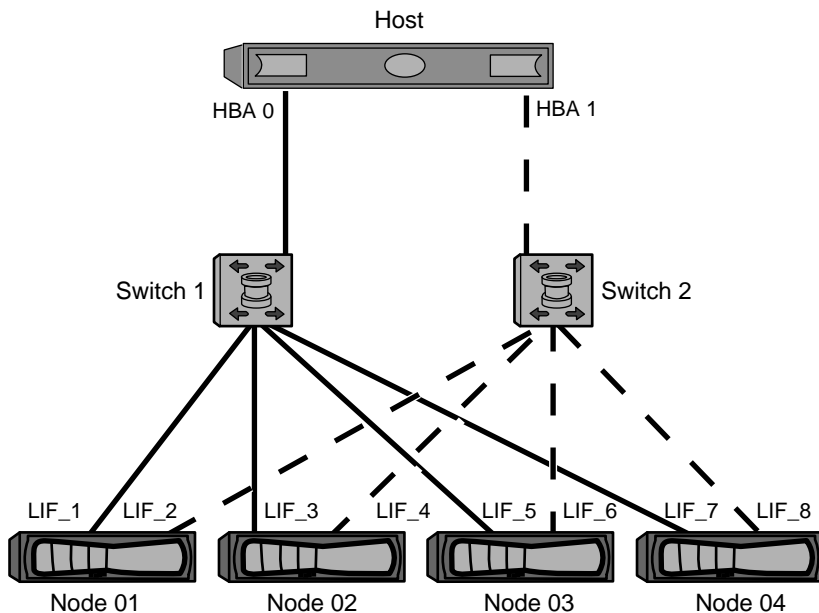

You must use the WWPNs of the target LIFs, not the WWPNs of the physical FC ports on the storage nodes. The LIF WWPNs are all in the range $2x:xx:00:a0:98:xx:xx:xx$, where x is any hexadecimal digit. The physical port WWPNs are all in the range $50:0a:09:8x:xx:xx:xx:xx$.

Steps

1. Log in to the FC switch administration program, and then select the zoning configuration option.
2. Create a new zone that includes the first initiator and all of the FC LIFs that connect to the same FC switch as the initiator.
3. Create additional zones for each FC initiator in the host.
4. Save the zones, and then activate the new zoning configuration.

Discovering new disks

LUNs on your storage virtual machine (SVM) appear as disks to the Windows host. Any new disks for LUNs you add to your system are not automatically discovered by the host. You must manually rescan disks to discover them.

Steps

1. Open the Windows Computer Management utility:

If you are using...	Navigate to...
Windows Server 2012	Tools > Computer Management
Windows Server 2008	Start > Administrative Tools > Computer Management
Windows Server 2016	Start > Administrative Tools > Computer Management

2. Expand the **Storage** node in the navigation tree.
3. Click **Disk Management**.
4. Click **Action > Rescan Disks**.

Initializing and formatting the LUN

When a new LUN is first accessed by the Windows host, it has no partition or file system. You must initialize the LUN, and optionally format it with a file system.

Before you begin

The LUN must have been discovered by the Windows host.

About this task

LUNs appear in Windows Disk Management as disks.

You can initialize the disk as a basic disk with a GPT or MBR partition table.

You typically format the LUN with a file system such as NTFS, but some applications use raw disks instead.

Steps

1. Start Windows Disk Management.
2. Right-click the LUN, and then select the required disk or partition type.
3. Follow the instructions in the wizard.

If you choose to format the LUN as NTFS, you must select the **Perform a quick format** check box.

Verifying that the host can write to and read from the LUN

Before using the LUN, you should verify that the host can write data to the LUN and read it back.

Before you begin

The LUN must be initialized and formatted with a file system.

About this task

If the storage cluster node on which the LUN is created can be failed over to its partner node, you should verify reading the data while the node is failed over. This test might not be possible if the storage cluster is in production use.

If any of the tests fail, you should verify that the FC service is running and check the FC paths to the LUN.

Steps

1. On the host, copy one or more files to the LUN.
2. Copy the files back to a different folder on the original disk.
3. Compare the copied files to the original.
You can use the `comp` command at the Windows command prompt to compare two files.
4. Optional: Fail over the storage cluster node containing the LUN and verify that you can still access the files on the LUN.
5. Use the native DSM to view the paths to the LUN and verify that you have the expected number of paths.

You should see two paths to the storage cluster node on which the LUN is created, and two paths to the partner node.

Where to find additional information

There are additional documents to help you learn more about FC configuration.

All of the following documentation is available:

- [*SAN configuration*](#)
Describes supported FC, iSCSI, and FCoE topologies for connecting host computers to storage controllers in clusters.
- [*SAN administration*](#)
Describes how to configure and manage the iSCSI, FCoE, and FC protocols for clustered SAN environments, including configuration of LUNs, igroups, and targets.

Copyright, trademark, and machine translation

Copyright

Copyright © 2021 NetApp, Inc. All rights reserved. Printed in the U.S.

No part of this document covered by copyright may be reproduced in any form or by any means—graphic, electronic, or mechanical, including photocopying, recording, taping, or storage in an electronic retrieval system—without prior written permission of the copyright owner.

Software derived from copyrighted NetApp material is subject to the following license and disclaimer:

THIS SOFTWARE IS PROVIDED BY NETAPP "AS IS" AND WITHOUT ANY EXPRESS OR IMPLIED WARRANTIES, INCLUDING, BUT NOT LIMITED TO, THE IMPLIED WARRANTIES OF MERCHANTABILITY AND FITNESS FOR A PARTICULAR PURPOSE, WHICH ARE HEREBY DISCLAIMED. IN NO EVENT SHALL NETAPP BE LIABLE FOR ANY DIRECT, INDIRECT, INCIDENTAL, SPECIAL, EXEMPLARY, OR CONSEQUENTIAL DAMAGES (INCLUDING, BUT NOT LIMITED TO, PROCUREMENT OF SUBSTITUTE GOODS OR SERVICES; LOSS OF USE, DATA, OR PROFITS; OR BUSINESS INTERRUPTION) HOWEVER CAUSED AND ON ANY THEORY OF LIABILITY, WHETHER IN CONTRACT, STRICT LIABILITY, OR TORT (INCLUDING NEGLIGENCE OR OTHERWISE) ARISING IN ANY WAY OUT OF THE USE OF THIS SOFTWARE, EVEN IF ADVISED OF THE POSSIBILITY OF SUCH DAMAGE.

NetApp reserves the right to change any products described herein at any time, and without notice. NetApp assumes no responsibility or liability arising from the use of products described herein, except as expressly agreed to in writing by NetApp. The use or purchase of this product does not convey a license under any patent rights, trademark rights, or any other intellectual property rights of NetApp.

The product described in this manual may be protected by one or more U.S. patents, foreign patents, or pending applications.

Data contained herein pertains to a commercial item (as defined in FAR 2.101) and is proprietary to NetApp, Inc. The U.S. Government has a non-exclusive, non-transferrable, non-sublicensable, worldwide, limited irrevocable license to use the Data only in connection with and in support of the U.S. Government contract under which the Data was delivered. Except as provided herein, the Data may not be used, disclosed, reproduced, modified, performed, or displayed without the prior written approval of NetApp, Inc. United States Government license rights for the Department of Defense are limited to those rights identified in DFARS clause 252.227-7015(b).

Trademark

NETAPP, the NETAPP logo, and the marks listed on the NetApp Trademarks page are trademarks of NetApp, Inc. Other company and product names may be trademarks of their respective owners.

<https://www.netapp.com/company/legal/trademarks/>

Machine translation

See important information about localized content at [netapp.com](https://www.netapp.com).

<https://www.netapp.com/company/legal/machine-translation/>