



Install

ONTAP Select

NetApp
May 07, 2026

Table of Contents

- Install 1
 - Pre-installation checklist 1
 - Host preparation checklist 1
 - Required information for ONTAP Select Deploy utility installation 10
 - Required information for ONTAP Select installation 11
 - Configure an ONTAP Select host to use NVMe drives 12
 - Install ONTAP Select Deploy 16
 - Step 1: Download the virtual machine image 16
 - Step 2: Verify the ONTAP Select Deploy OVA signature 17
 - Step 3: Deploy the virtual machine 17
 - Step 4: Sign in to the Deploy web interface 20
 - Deploy an ONTAP Select cluster 21
 - Step 1: Prepare for the deployment 21
 - Step 2: Create a single-node or multi-node cluster 22
 - Step 3: Complete the deployment 25
 - Initial state of the ONTAP Select cluster after deployment 25

Install

Pre-installation checklist

Host preparation checklist

KVM host configuration and preparation checklist for ONTAP Select

Prepare each KVM hypervisor host where an ONTAP Select node is deployed. As you prepare the hosts, you carefully assess the deployment environment to make sure that the hosts are correctly configured and ready to support the deployment of an ONTAP Select cluster.



The ONTAP Select Deploy administration utility doesn't perform the required network and storage configuration of the hypervisor hosts. You must manually prepare each host before deploying an ONTAP Select cluster.

Step 1: Prepare the KVM hypervisor host

You need to prepare each of the Linux KVM servers where an ONTAP Select node is deployed. You must also prepare the server where the ONTAP Select Deploy administration utility is deployed.

Steps

1. Install Red Hat Enterprise Linux (RHEL).

Install the RHEL operating system using the ISO image. Refer to the [software compatibility information for hypervisors](#) for a list of the supported RHEL versions. During installation, configure the system as follows:

- a. Select Default as the security policy.
- b. Choose the Virtualized Host software selection.
- c. Verify that the destination is the local boot disk and not a RAID LUN used by ONTAP Select.
- d. Verify that the host management interface is up after you boot the system.



You can edit the correct network configuration file under `/etc/sysconfig/network-scripts` and then bring up the interface by using the `ifup` command.

2. Install additional packages required for ONTAP Select.

ONTAP Select requires several additional software packages. The exact list of packages varies based on the version of Linux that you're using. As a first step, verify that the yum repository is available on your server. If it isn't available, you can retrieve it by using the `wget your_repository_location` command.



Some of the required packages might already be installed if you chose Virtualized Host for the software selection during installation of the Linux server. You might need to install the `openvswitch` package from source code as described in the [Open vSwitch documentation](#).

For additional information about the necessary packages and other configuration requirements, refer to the [Interoperability Matrix Tool](#).

3. Configure PCI passthrough for NVMe disks.

If you're using NVMe disks in your configuration, you need to configure PCI passthrough (DirectPath IO) to provide direct access for the KVM host to the locally attached NVMe disks in the ONTAP Select cluster. You need direct access to perform the following tasks:

- [Configure the KVM host to use NVMe drives](#)
- [Use software RAID after you deploy the cluster](#)

Refer to the [Red Hat Documentation](#) for instructions on how to configure PCI passthrough (DirectPath IO) for a KVM hypervisor.

4. Configure the storage pools.

An ONTAP Select storage pool is a logical data container that abstracts the underlying physical storage. You must manage the storage pools on the KVM hosts where ONTAP Select is deployed.

Step 2: Create a storage pool

Create at least one storage pool at each ONTAP Select node. If you use software RAID instead of a local hardware RAID, storage disks are attached to the node for the root and data aggregates. In this case, you must still create a storage pool for the system data.

Before you begin

Verify that you can sign in to the Linux CLI on the host where ONTAP Select is deployed.

About this task

The ONTAP Select Deploy administration utility expects the target location for the storage pool to be specified as `/dev/<pool_name>`, where `<pool_name>` is a unique pool name on the host.



The entire capacity of the LUN is allocated when a storage pool is created.

Steps

1. Display the local devices on the Linux host and choose the LUN that will contain the storage pool:

```
lsblk
```

The appropriate LUN is likely to be the device with the largest storage capacity.

2. Define the storage pool on the device:

```
virsh pool-define-as <pool_name> logical --source-dev <device_name>
--target=/dev/<pool_name>
```

For example:

```
virsh pool-define-as select_pool logical --source-dev /dev/sdb
--target=/dev/select_pool
```

3. Build the storage pool:

```
virsh pool-build <pool_name>
```

4. Start the storage pool:

```
virsh pool-start <pool_name>
```

5. Configure the storage pool to automatically start at system boot:

```
virsh pool-autostart <pool_name>
```

6. Verify that the storage pool has been created:

```
virsh pool-list
```

Step 3: Optionally, delete a storage pool

You can delete a storage pool when it's no longer needed.

Before you begin

Verify that you can sign in to the Linux CLI where ONTAP Select is deployed.

About this task

The ONTAP Select Deploy administration utility expects the target location for the storage pool to be specified as `/dev/<pool_name>`, where `<pool_name>` is a unique pool name on the host.

Steps

1. Verify that the storage pool is defined:

```
virsh pool-list
```

2. Destroy the storage pool:

```
virsh pool-destroy <pool_name>
```

3. Undefine the configuration for the inactive storage pool:

```
virsh pool-undefine <pool_name>
```

4. Verify that the storage pool has been removed from the host:

```
virsh pool-list
```

5. Verify that all logical volumes for the storage pool volume group have been deleted.

a. Display the logical volumes:

```
lvs
```

b. If any logical volumes exist for the pool, delete them:

```
lvremove <logical_volume_name>
```

6. Verify that the volume group has been deleted:

a. Display the volume groups:

```
vgs
```

b. If a volume group exists for the pool, delete it:

```
vgremove <volume_group_name>
```

7. Verify that the physical volume has been deleted:

a. Display the physical volumes:

```
pvs
```

b. If a physical volume exists for the pool, delete it:

```
pvremove <physical_volume_name>
```

Step 4: Review the ONTAP Select cluster configuration

You can deploy ONTAP Select as either a multi-node cluster or a single-node cluster. In many cases, a multi-node cluster is preferable because of the additional storage capacity and high-availability (HA) capability.

The following figures illustrate the ONTAP Select networks used with a single-node cluster and four-node cluster for an ESXi host.

Single-node cluster

The following figure illustrates a single-node cluster. The external network carries client, management, and cross-cluster replication traffic (SnapMirror/SnapVault).

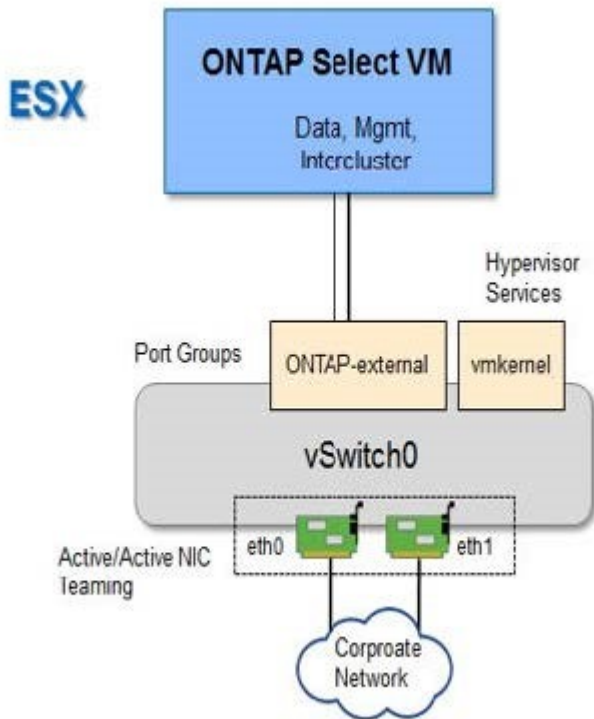

Four-node cluster

The following figure illustrates a four-node cluster showing two networks. The internal network enables communication among the nodes in support of the ONTAP cluster network services. The external network carries client, management, and cross-cluster replication traffic (SnapMirror/SnapVault).

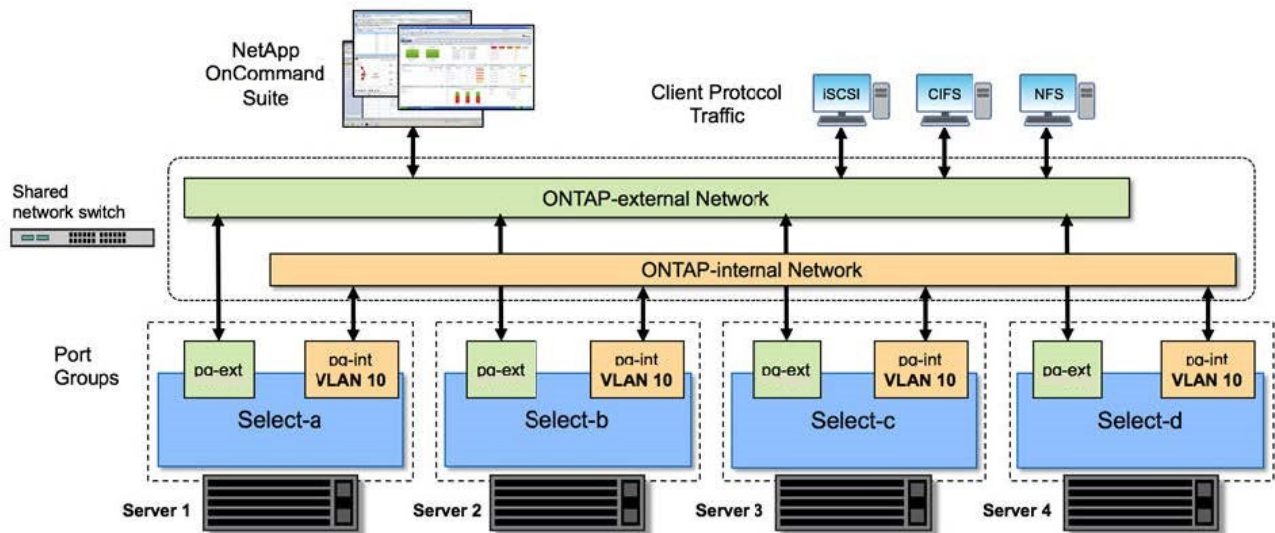

Single node within a four-node cluster

The following figure illustrates the typical network configuration for a single ONTAP Select virtual machine within a four-node cluster. There are two separate networks: ONTAP-internal and ONTAP-external.

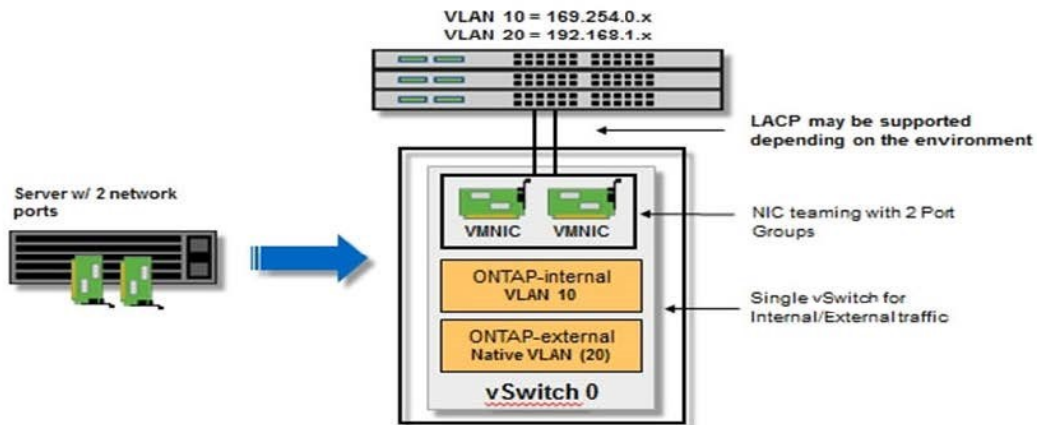

Step 5: Configure Open vSwitch

Use Open vSwitch to configure a software-defined switch on each KVM host node.

Before you begin

Verify that the network manager is disabled and the native Linux network service is enabled.

About this task

ONTAP Select requires two separate networks, both of which utilize port bonding to provide HA capability for the networks.

Steps

1. Verify that Open vSwitch is active on the host:
 - a. Determine if Open vSwitch is running:

```
systemctl status openvswitch
```

- b. If Open vSwitch is not running, start it:

```
systemctl start openvswitch
```

2. Display the Open vSwitch configuration:

```
ovs-vsctl show
```

The configuration appears empty if Open vSwitch has not already been configured on the host.

3. Add a new vSwitch instance:

```
ovs-vsctl add-br <bridge_name>
```

For example:

```
ovs-vsctl add-br ontap-br
```

4. Bring the network interfaces down:

```
ifdown <interface_1>  
ifdown <interface_2>
```

5. Combine the links using the Link Aggregation Control Protocol (LACP):

```
ovs-vsctl add-bond <internal_network> bond-br <interface_1>  
<interface_2> bond_mode=balance-slb lacp=active other_config:lacp-  
time=fast
```



You only need to configure a bond if there is more than one interface.

6. Bring the network interfaces up:

```
ifup <interface_1>  
ifup <interface_2>
```

ESXi host configuration and preparation checklist for ONTAP Select

Prepare each ESXi hypervisor host where an ONTAP Select node is deployed. As you prepare the hosts, you carefully assess the deployment environment to make sure that the hosts are correctly configured and ready to support the deployment of an ONTAP Select cluster.



The ONTAP Select Deploy administration utility doesn't perform the required network and storage configuration of the hypervisor hosts. You must manually prepare each host before deploying an ONTAP Select cluster.

Step 1: Prepare the ESXi hypervisor host

Verify the configuration for the ESXi host and the firewall ports.

Steps

1. Verify that each ESXi is configured with the following:
 - A pre-installed and supported hypervisor
 - A VMware vSphere license
2. Verify that the same vCenter server can manage all the hosts where an ONTAP Select node is deployed within the cluster.
3. Verify that the firewall ports are configured to allow access to vSphere. These ports must be open to support serial port connectivity to the ONTAP Select virtual machines.

Recommended

NetApp recommends that you open the following firewall ports to allow access to vSphere:

- Ports 7200 – 7400 (both inbound and outbound traffic)

Default

By default, VMware allows access on the following ports:

- Port 22 and ports 1024 – 65535 (inbound traffic)
- Ports 0 – 65535 (outbound traffic)

For more information, refer to the [Broadcom VMware vSphere documentation](#).

4. Familiarize yourself with the vCenter rights that are required. See [VMware vCenter server](#) for more information.

Step 2: Review the ONTAP Select cluster configuration

You can deploy ONTAP Select as either a multi-node cluster or a single-node cluster. In many cases, a multi-node cluster is preferable because of the additional storage capacity and high-availability (HA) capability.

The following figures illustrate the ONTAP Select networks used with a single-node cluster and four-node cluster.

Single-node cluster

The following figure illustrates a single-node cluster. The external network carries client, management, and cross-cluster replication traffic (SnapMirror/SnapVault).

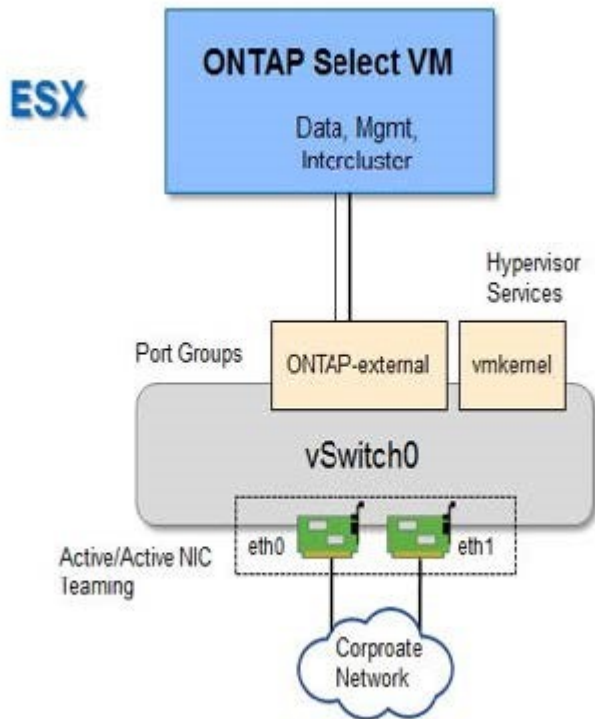

Four-node cluster

The following figure illustrates a four-node cluster showing two networks. The internal network enables communication among the nodes in support of the ONTAP cluster network services. The external network carries client, management, and cross-cluster replication traffic (SnapMirror/SnapVault).

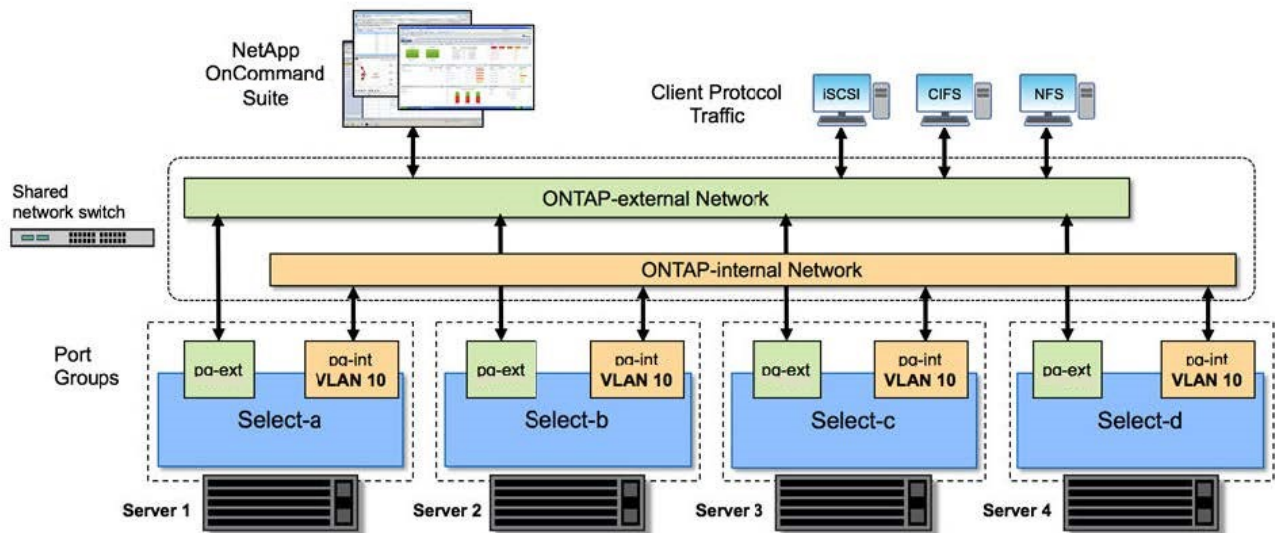

Single node within a four-node cluster

The following figure illustrates the typical network configuration for a single ONTAP Select virtual machine within a four-node cluster. There are two separate networks: ONTAP-internal and ONTAP-external.

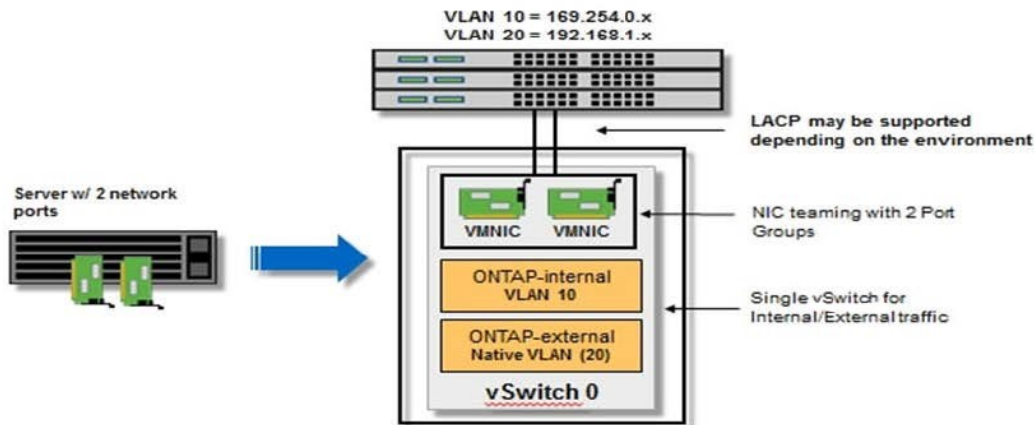

Required information for ONTAP Select Deploy utility installation

Before installing the Deploy administration utility in a hypervisor environment, review the required configuration information and optional network configuration information to prepare for successful deployment.

Required configuration information

As part of your deployment planning, you should determine the required configuration information before installing the ONTAP Select Deploy administration utility.

Required information	Description
Name of the Deploy virtual machine	Identifier to use for the virtual machine.
Name of the hypervisor host	Identifier for the VMware ESXi or KVM hypervisor host where the Deploy utility is installed.
Name of the data store	Identifier for the hypervisor data store holding the virtual machine files (approximately 40GB is required).
Network for the virtual machine	Identifier for the Network where the Deploy virtual machine is connected.

Optional network configuration information

The Deploy virtual machine is configured using DHCP by default. However, if needed, you can manually configure the network interface for the virtual machine.

Network information	Description
Host name	Identifier of the host machine.
Host IP address	Static IPv4 address of the host machine.
Subnet mask	Subnetwork mask, based on the network the virtual machine is a part of.
Gateway	Default gateway or router.
Primary DNS server	Primary Domain Name Server.
Secondary DNS server	Secondary Domain Name Server.
Search domains	List of the search domains to use.

Required information for ONTAP Select installation

As part of preparing to deploy an ONTAP Select cluster in a VMware environment, collect the information required when using the ONTAP Select Deploy administration utility to deploy and configure the cluster.

Some of the information you collect applies to the cluster itself, while other information applies to the individual nodes in the cluster.

Cluster-level information

You must collect information related to the ONTAP Select cluster.

Cluster information	Description
Name of the cluster	Unique identifier of the cluster.
Licensing mode	Evaluation or purchased licensing.
IP configuration for the cluster	IP configuration for the clusters and nodes, including: <ul style="list-style-type: none"> * Management IP address of the cluster * Subnet mask * Default gateway

Host-level information

You must collect information related to each of the nodes in the ONTAP Select cluster.

Cluster information	Description
Name of the host	Unique identifier of the host.
Domain name of the host	Fully qualified domain name of the host.
IP configuration for the nodes	Management IP address for each node in the cluster.
Mirror node	Name of the associated node in the HA pair (multi-node clusters only).
Storage pool	Name of the storage pool that is used.
Storage disks	List of disks if using software RAID.

Cluster information	Description
Serial number	If you are deploying with a purchased license, the unique nine-digit serial number provided by NetApp.

Configure an ONTAP Select host to use NVMe drives

If you plan to use NVMe drives with software RAID, you need to configure the ESXi or KVM host to recognize the drives.

Use VMDirectPath I/O Pass-through on the NVMe devices to maximize data efficiency. This setting exposes the drives to the ONTAP Select virtual machine, allowing ONTAP to have direct PCI access to the device.

Step 1: Configure the host

Configure the ESXi or KVM host to recognize the drives.

Before you begin

Make sure your deployment environment meets the following minimum requirements:

- For an ESXi host, ONTAP Select 9.7 or later with a supported Deploy administration utility
- For a KVM host, ONTAP Select 9.17.1 or later with a supported Deploy administration utility
- Premium XL platform license offering or a 90-day evaluation license
- The ESXi or KVM host is running a supported hypervisor version:

ESXi

ESXi is supported on the following hypervisor versions:

- VMware ESXi 9.0
- VMware ESXi 8.0 U3
- VMware ESXi 8.0 U2
- VMware ESXi 8.0 U1 (build 21495797)
- VMware ESXi 8.0 GA (build 20513097)

KVM

KVM is supported on the following hypervisor versions:

- Red Hat Enterprise Linux (RHEL) 10.1, 10.0, 9.7, 9.6, 9.5, 9.4, 9.2, 9.1, 9.0, 8.8, 8.7, and 8.6
- Rocky Linux 10.1, 10.0, 9.7, 9.6, 9.5, 9.4, 9.3, 9.2, 9.1, 9.0, 8.9, 8.8, 8.7, and 8.6

- NVMe devices conforming to specification 1.0 or later

Follow the [host preparation checklist](#), and review the required information for the [deploy utility installation](#) and the [ONTAP Select installation](#) for more information.

About this task

You must perform this procedure before creating a new ONTAP Select cluster. You can also perform the procedure to configure additional NVMe drives for an existing software RAID NVMe cluster. In this case, after

configuring the drives, you must add them through Deploy as you would additional SSD drives. The main difference is that Deploy detects the NVMe drives and reboots the nodes. When adding NVMe drives to an existing cluster, note the following about the reboot process:

- Deploy handles the reboot orchestration.
- HA takeover and giveback is performed in an orderly fashion, but it can be time consuming to resynchronize the aggregates.
- A single-node cluster will incur downtime.

See [Increase storage capacity](#) for additional information.

Steps

1. Access the **BIOS configuration** menu on the host to enable support for I/O virtualization.
2. Enable the **Intel VT for Directed I/O (VT-d)** setting.

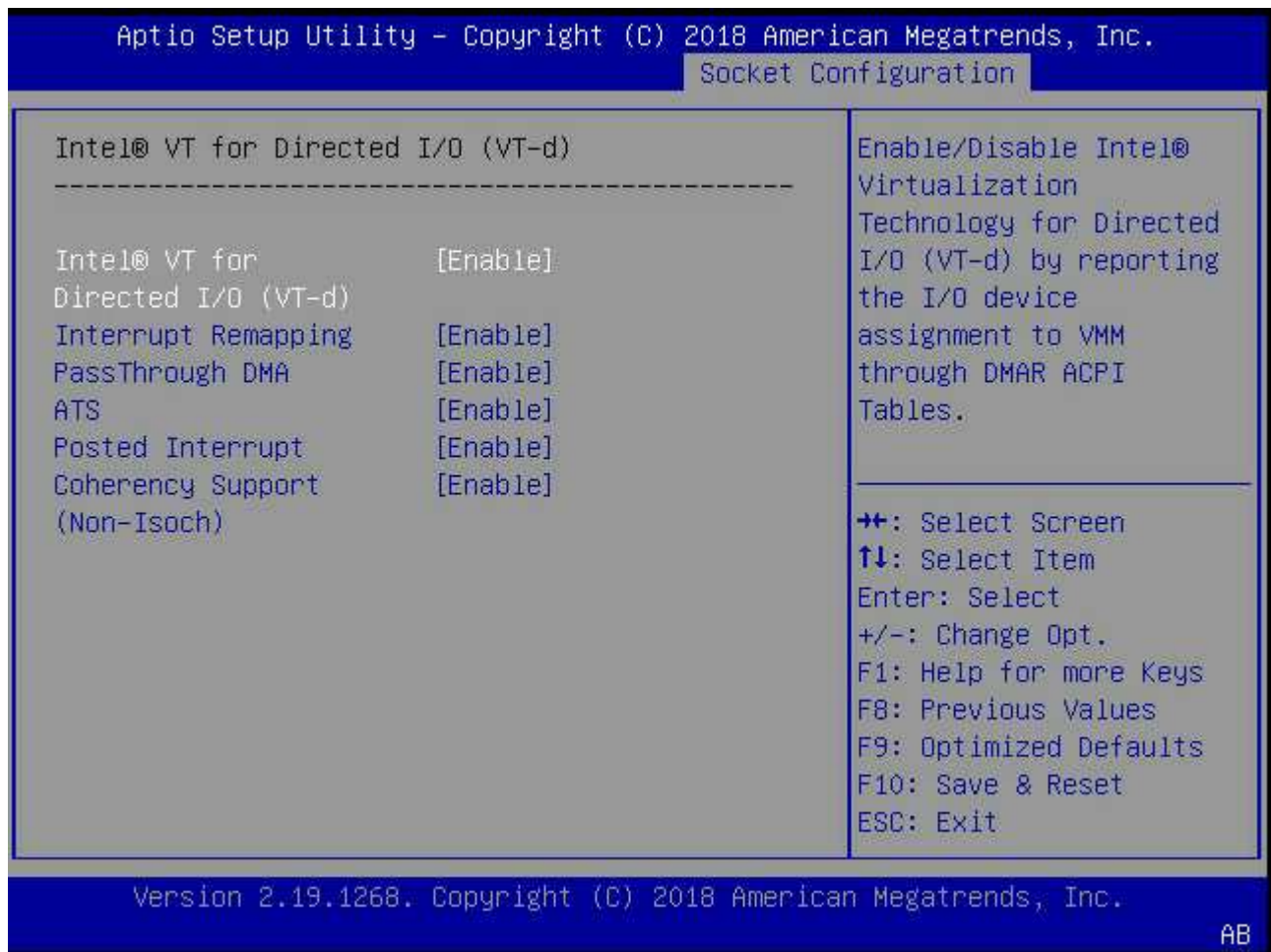

3. Some servers offer support for **Intel Volume Management Device (Intel VMD)**. When enabled, this makes the available NVMe devices invisible to the ESXi or KVM hypervisor; disable this option before proceeding.
4. Configure the NVMe drives for pass-through to virtual machines.
 - a. In vSphere, open the host **Configure** view and select **Edit** under **Hardware: PCI devices**.
 - b. Select the NVMe drives you want to use for ONTAP Select.

The following example output shows the available drives for an ESXi host:

Edit PCI Device Availability | [sdot-dl380-003.gdl.englab.netapp.com](#) ✕

ID	Status	Vendor Name	Device Name	ESX/ESXi Device
0000:36:01.0	Not Configurable	Intel Corporation	Sky Lake-E PCI Expres...	
<input checked="" type="checkbox"/> 0000:38:...	Available (pending)	Seagate Technology ...	Nytro Flash Storage	
0000:36:02.0	Not Configurable	Intel Corporation	Sky Lake-E PCI Expres...	
<input checked="" type="checkbox"/> 0000:39:...	Available (pending)	Seagate Technology ...	Nytro Flash Storage	

No items selected



You need a VMFS datastore that is also backed by an NVMe device to host the ONTAP Select VM system disks and virtual NVRAM. Leave at least one NVMe drive available for this purpose when configuring the others for PCI pass-through.

c. Select **OK**. The selected devices indicate **Available (pending)**.

5. Select **Reboot This Host**.

The following example output is for an ESXi host:

Configure | Permissions | VMs | Datastores | Networks | Updates

DirectPath I/O PCI Devices Available to VMs

ID	Status	Vendor Name	Device Name
0000:12:00.0	Available (pending)	Seagate Technology PLC	Nytro Flash Storage
0000:13:00.0	Available (pending)	Seagate Technology PLC	Nytro Flash Storage
0000:14:00.0	Available (pending)	Seagate Technology PLC	Nytro Flash Storage
0000:15:00.0	Available (pending)	Seagate Technology PLC	Nytro Flash Storage
0000:37:00.0	Available (pending)	Seagate Technology PLC	Nytro Flash Storage
0000:38:00.0	Available (pending)	Seagate Technology PLC	Nytro Flash Storage

7 devices will become available when this host is rebooted.

Step 2: Install the ONTAP Select Deploy utility

After the hosts are prepared, you can install the ONTAP Select Deploy utility. Deploy guides you through creating ONTAP Select storage clusters on your newly prepared hosts. During this process, Deploy detects the presence of the NVMe drives configured for pass-through and automatically selects them for use as ONTAP data disks. You can adjust the default selection if needed.



A maximum of 14 NVMe devices are supported for each ONTAP Select node.

The following example output is for an ESXi host:

The screenshot shows the ONTAP Select Deploy utility interface. The top navigation bar includes 'Clusters', 'Hypervisor Hosts', and 'Administration'. The 'Storage' section is active, showing 'Storage Configuration' with 'RAID Type' set to 'Software RAID' and 'Data Disk Type' set to 'NVME'. The 'System Disk' is set to 'nvme-snc-01' with a capacity of 1.41 TB. Below this, a table titled 'Data Disks for nvme-snc-01' lists seven NVMe devices, all of which are selected with checkmarks. The table columns are 'Device Name', 'Device Type', and 'Capacity'. A 'Done' button is located at the bottom right of the table area.

Device Name	Device Type	Capacity
<input checked="" type="checkbox"/> 0000:12:00.0	NVME	-
<input checked="" type="checkbox"/> 0000:13:00.0	NVME	-
<input checked="" type="checkbox"/> 0000:14:00.0	NVME	-
<input checked="" type="checkbox"/> 0000:15:00.0	NVME	-
<input checked="" type="checkbox"/> 0000:37:00.0	NVME	-
<input checked="" type="checkbox"/> 0000:38:00.0	NVME	-
<input checked="" type="checkbox"/> 0000:39:00.0	NVME	-

Selected Capacity: (7/7 disks)

Done

After the cluster is successfully deployed, ONTAP System Manager allows you to provision the storage according to best practices. ONTAP automatically enables flash-optimized storage efficiency features that make the best use of your NVMe storage.

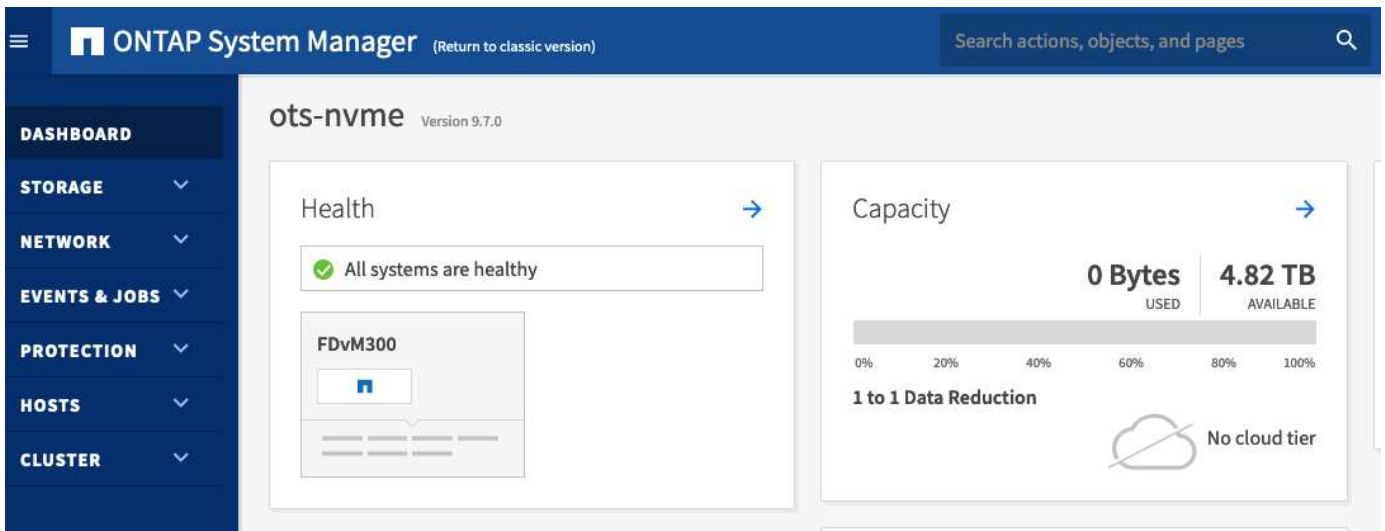
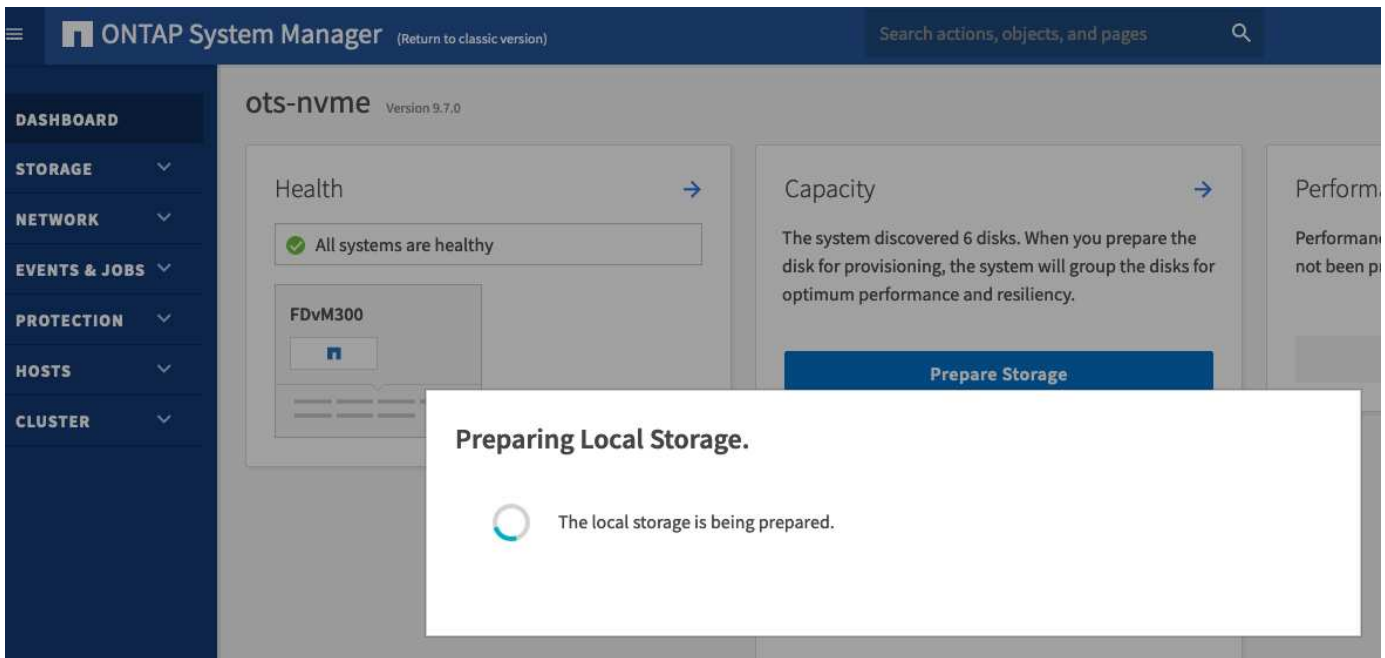

Install ONTAP Select Deploy

You need to install the ONTAP Select Deploy administration utility and use the utility to create an ONTAP Select cluster.

Step 1: Download the virtual machine image

Download the ONTAP Select package from the NetApp support site.

Before you begin

[You have a registered NetApp Support Site account.](#)

About this task

The ONTAP Select Deploy administration utility is packaged as a virtual machine (VM) based on the Open Virtualization Format (OVF) standard. The single compressed file has the suffix `OVA` for ESXi hosts and `TGZ` for KVM hosts. The VM provides the Deploy server and installation images for ONTAP Select nodes.

Steps

1. Access the [NetApp Support Site downloads](#) page.
2. Scroll down and select **ONTAP Select Deploy**.
3. Select the desired ONTAP Select version.
4. Review the End User License Agreement (EULA) and select **Accept & Continue**.
5. Select and download the appropriate **ONTAP Select Deploy Install** package. Respond to all prompts as needed.

Step 2: Verify the ONTAP Select Deploy OVA signature

Verify the ONTAP Select Open Virtualization Appliance (OVA) signature before installing the installation package.

Before you begin

Verify that your system meets the following requirements:

- OpenSSL versions 1.0.2 to 3.0 for basic verification
- Public internet access for Online Certificate Status Protocol (OCSP) verification

Steps

1. Obtain the following files from the product download page on the NetApp support site:

File	Description
ONTAP-Select-Deploy-Production.pub	The public key used to verify the signature.
csc-prod-chain-ONTAP-Select-Deploy.pem	The public certification authority (CA) chain of trust.
csc-prod-ONTAP-Select-Deploy.pem	The certificate used to generate the key.
ONTAPdeploy.ova	The product installation executable for ONTAP Select.
ONTAPdeploy.ova.sig	The SHA-256 algorithm is hashed and then signed by the Remote Support Agent (RSA) using the <code>csc-prod</code> key and signature for the installer.

2. Verify that the `ONTAPdeploy.ova.sig` file is using the associated certificates and validation commands.
3. Verify the signature:

```
openssl dgst -sha256 -verify ONTAP-Select-Deploy-Production.pub  
-signature ONTAPdeploy.ova.sig ONTAPdeploy.ova
```

Step 3: Deploy the virtual machine

Install and start the ONTAP Select Deploy VM using the OVF VM image. As part of the installation process, you configure the network interface to use DHCP or a static IP configuration.

Before you begin

For an ESXi hypervisor, you must prepare to deploy the ONTAP Select Deploy VM:

- Enable the OVF functionality in your browser by installing the VMware Client Integration Plugin or performing similar configuration as needed
- Enable the DHCP in the VMware environment if you will dynamically assign an IP address to the Deploy VM

For ESXi and KVM hypervisors, you must have the configuration information to be used when creating the VM, including the name of the VM, external network, and host name. When defining a static network configuration, you need the following additional information:

- IP address of the Deploy VM
- Netmask
- IP address of the gateway (router)
- IP address of the primary DNS server
- IP address of the second DNS server
- DNS search domains

About this task

If you use vSphere, the Deploy OVF template wizard includes a form to provide all of the Deploy configuration information, including the network configuration. However, if you choose not to use this form, you can use the console of the Deploy VM to configure the network instead.

Steps

The steps you follow depend on whether you use an ESXi or KVM hypervisor.

ESXi

1. Access the vSphere client and sign in.
2. Navigate to the appropriate location in the hierarchy and select **Deploy OVF Template**.
3. Select the OVA file and complete the Deploy OVF Template wizard. Select the options that are appropriate for your environment.

You must define the password for the administrator account. You need to provide this password when signing in to the Deploy utility.

4. After the VM is deployed, select the new VM. If it isn't already powered on based on your input to the deployment wizard, power it on manually.
5. If needed, you can configure the Deploy network using the VM console:
 - a. Select the **Console** tab to access the ESXi host setup shell and monitor the power on process.
 - b. Wait for the following prompt:

Host name :

- c. Type the host name and press **Enter**.
- d. Wait for the following prompt:

Provide a password for the admin user:

- e. Type the password and press **Enter**.
- f. Wait for the following prompt:

Use DHCP to set networking information? [n]:

- g. Type **n** to define a static IP configuration or **y** to use the DHCP, and select **Enter**.
- h. If you choose a static configuration, provide all the required network configuration information.

KVM

1. Sign in to the CLI at the Linux server:

```
ssh root@<ip_address>
```

2. Create a new directory and extract the raw VM image:

```
mkdir /home/select_deploy25
cd /home/select_deploy25
mv /root/<file_name> .
tar -xzvf <file_name>
```

3. Create and start the KVM VM running the Deploy administration utility:

```
virt-install --name=select-deploy --vcpus=2 --ram=4096 --os
-variant=debian10 --controller=scsi,model=virtio-scsi --disk
path=/home/deploy/ONTAPdeploy.raw,device=disk,bus=scsi,format=raw
--network "type=bridge,source=ontap-
br,model=virtio,virtualport_type=openvswitch" --console=pty --import
--noautoconsole
```

4. If needed, you can configure the Deploy network using the VM console:

a. Connect to the VM console:

```
virsh console <vm_name>
```

b. Wait for the following prompt:

```
Host name :
```

c. Type the host name and select **Enter**.

d. Wait for the following prompt:

```
Use DHCP to set networking information? [n]:
```

e. Type **n** to define a static IP configuration or **y** to use the DHCP, and select **Enter**.

f. If you choose a static configuration, provide all network configuration information as required.

Step 4: Sign in to the Deploy web interface

Sign in to the web user interface to confirm the Deploy utility is available and perform the initial configuration.

Steps

1. Point your browser to the Deploy utility using the IP address or domain name:

```
https://<ip_address>/
```

2. Provide the administrator (admin) account name and password and sign in.

3. If the **Welcome to ONTAP Select** pop-up window is displayed, review the prerequisites and select **OK** to continue.

4. If this is the first time signing in and you did not install Deploy using the wizard available with vCenter, provide the following configuration information when prompted:

- New password for the administrator account (required)
- AutoSupport (optional)
- vCenter server with account credentials (optional)

What's next:

[Deploy an ONTAP Select cluster](#)

Related information

- [Learn about signing in to Deploy using SSH](#)
- [Learn about deploying a 90-day evaluation instance of an ONTAP Select cluster](#)

Deploy an ONTAP Select cluster

You can use the web user interface provided with the ONTAP Select Deploy administration utility to deploy a single-node or multi-node ONTAP Select cluster.

When you create an ONTAP Select cluster using the Deploy utility web interface, you are guided through a specific sequence of steps. The exact process varies depending on whether you deploy a single-node or multi-node cluster.



You can also [deploy ONTAP Select clusters using the Deploy utility CLI](#).

Step 1: Prepare for the deployment

Prepare for the deployment to make sure it's successful.

Steps

1. Initial planning.

Review the [Plan](#) and [License](#) sections. Based on this review, you can make decisions about the cluster, including:

- Hypervisor
- Number of nodes
- License type
- Platform size (instance type)
- ONTAP Select version

2. Prepare the host.

You must prepare the hypervisor hosts where the ONTAP Select nodes will run and have the needed storage license files based on your licensing model. To view the preparation requirements:

- Sign in to the Deploy web UI.
- Select  at the top of the page.
- Select **Prerequisites**.
- Scroll down to review the requirements and select **OK**.

3. Acquire the license files.

If you plan to deploy the cluster in a production environment, you must acquire the storage license files based on your licensing model.

4. Deploy installation and account credentials.

[Install the Deploy administration utility and perform initial configuration](#). You need to have the password for the Deploy administrator account that was configured as part of the installation process.

5. Optionally, install earlier ONTAP Select node images.

By default, the Deploy administration utility contains the most current version of ONTAP Select at the time of release. If you want to deploy clusters using an earlier version of ONTAP Select, you need to [add the ONTAP Select image to your Deploy instance](#).

6. Learn about the "Getting started" launch page.

The initial page **Getting Started with ONTAP Select Deploy** guides you through the multi-step process of creating a cluster. There are five major steps, including:

- Add licenses
- Add hosts to inventory
- Create a cluster
- Network precheck
- Deploy the cluster



You can perform the same steps independently by selecting the tabs at the top of the page (Clusters, Hypervisor Hosts, Administration).

7. Review the network checker.

If you are deploying a multi-node cluster, you should be familiar with the network checker. You can run the network connectivity checker using the [web UI](#) or the [CLI](#).

Step 2: Create a single-node or multi-node cluster

You can use the ONTAP Select Deploy web user interface to deploy a single-node or multi-node ONTAP Select cluster.

Before you begin

Verify that you have installed the Deploy administration and completed the initial configuration (password, AutoSupport, and vCenter).

About this task

An ONTAP Select cluster with one or more nodes is created for a production deployment.

Steps

The steps you follow depend on whether you want to create a single-node cluster or a multi-node cluster. A multi-node cluster can have two, four, six, eight, ten, or twelve nodes.

Single-node cluster

1. Sign in to the Deploy utility through the web interface using the administrator account (admin).
2. If the **Welcome to ONTAP Select** pop-up window is displayed, confirm you have met the configuration prerequisites and select **OK**.
3. If the **Getting Started** cluster launch page is not displayed, select  at the top of the page and select **Getting Started**.
4. On the **Getting Started** page, select **Upload**, and then select a license from your local workstation and select **Open** to upload the license.
5. Select **Refresh** and confirm the license has been added.
6. Select **Next** to add a hypervisor host and then select **Add**.

You can add the hypervisor host directly or by connecting to a vCenter server. Provide the appropriate host details and credentials as needed.

7. Select **Refresh** and confirm the **Type** value for the host is **ESX** or **KVM**.

Any account credentials you provide are added to the Deploy credential database.

8. Select **Next** to begin the cluster creation process.
9. In the **Cluster Details** section, provide all the required information describing the cluster and select **Done**.
10. Under **Node Setup**, provide the node management IP address and select the license for the node; you can upload a new license if needed. You also can change the node name if needed.
11. Provide the **Hypervisor** and **Network** configuration.

There are three node configurations which define the virtual machine size and available feature set. These instance types are supported by the standard, premium, and premium XL offerings of the purchased license, respectively. The license you select for the node must match or exceed the instance type.

Select the hypervisor host as well as the management and data networks.

12. Provide the **Storage** configuration and select **Done**.

You can select the drives based on your platform license level and host configuration.

13. Review and confirm the configuration of the cluster.

You can change the configuration by selecting  in the applicable section.

14. Select **Next** and provide the ONTAP administrator password.
15. Select **Create Cluster** to begin the cluster creation process and then select **OK** in the pop-up window.

It can take up to 30 minutes for the cluster to be created.

16. Monitor the multi-step cluster creation process to confirm the cluster is created successfully.

The page is automatically refreshed at regular intervals.

Multi-node cluster

1. Sign in to the Deploy utility through the web interface using the administrator account (admin).
2. If the **Welcome to ONTAP Select** popup window is displayed, confirm that you have met the configuration prerequisites and select **OK**.
3. If the **Getting Started** cluster launch page is not displayed, select  at the top of the page and select **Getting Started**.
4. On the **Getting Started** page, select **Upload** and select a license from your local workstation and select **Open** to upload the license. Repeat to add additional licenses.
5. Select **Refresh** and confirm the licenses have been added.
6. Select **Next** to add all hypervisor hosts and then select **Add**.

You can add the hypervisor hosts directly or by connecting to a vCenter server. Provide the appropriate host details and credentials as needed.

7. Select **Refresh** and confirm the **Type** value for the host is **ESX** or **KVM**.

Any account credentials you provide are added to the Deploy credential database.

8. Select **Next** to begin the cluster creation process.
9. In the **Cluster Details** section, select the desired **Cluster Size**, provide all the required information describing the clusters, and select **Done**.
10. Under **Node Setup**, provide the node management IP addresses and select the licenses for each node; you can upload a new license if needed. You also can change the node names if needed.
11. Provide the **Hypervisor** and **Network** configuration.

There are three node configurations which define the virtual machine size and available feature set. These instance types are supported by the standard, premium, and premium XL offerings of the purchased license, respectively. The license you select for the nodes must match or exceed the instance type.

Select the hypervisor hosts as well as the management, data, and internal networks.

12. Provide the **Storage** configuration and select **Done**.

You can select the drives based on your platform license level and host configuration.

13. Review and confirm the configuration of the cluster.

You can change the configuration by selecting  in the applicable section.

14. Select **Next** and run the Network Precheck by selecting **Run**. This validates that the internal network selected for ONTAP cluster traffic is functioning correctly.
15. Select **Next** and provide the ONTAP administrator password.
16. Select **Create Cluster** to begin the cluster creation process, and then select **OK** in the popup window.

It can take up to 45 minutes for the cluster to be created.

17. Monitor the multi-step cluster creation process to confirm that the cluster is created successfully.

The page is automatically refreshed at regular intervals.

Step 3: Complete the deployment

After deploying the cluster, [confirm the ONTAP Select AutoSupport feature is configured](#) and then [back up the ONTAP Select Deploy configuration data](#).



If the cluster creation operation is initiated but fails to complete, the ONTAP administrative password you define might not be applied. If this occurs, you can determine the temporary administrative password for the ONTAP Select cluster by using the following CLI command:

```
(ONTAPdeploy) !/opt/netapp/tools/get_cluster_temp_credentials  
--cluster-name my_cluster
```

Initial state of the ONTAP Select cluster after deployment

You should be aware of the initial state of a cluster after it has been deployed and configure the cluster as needed for your environment.

An ONTAP Select cluster has several characteristics after it is created.



Restricting roles and permissions for the ONTAP administrator account can limit ONTAP Select Deploy's ability to manage the cluster. For more information, refer to the Knowledge Base article [OTS Deploy cluster refresh fails with error](#).

LIFs

There are two types of customer-specified LIFs assigned:

- Cluster management (one per cluster)
- Node management (one per node)



A multi-node cluster has an internal network with autogenerated LIFs.

SVMs

Three SVMs are active:

- Admin SVM
- Node SVM
- System (cluster) SVM



Data SVMs aren't created as part of the ONTAP Select cluster deployment. They must be created by the cluster administrator after deployment. For more information, see [Create an SVM](#).

Aggregates

The root aggregate is created.

Features

All features are licensed and available. Both SnapLock and FabricPool require separate licenses.

Related information

- [Types of SVMs contained in a cluster](#)
- [ONTAP features enabled by default](#)

Copyright information

Copyright © 2026 NetApp, Inc. All Rights Reserved. Printed in the U.S. No part of this document covered by copyright may be reproduced in any form or by any means—graphic, electronic, or mechanical, including photocopying, recording, taping, or storage in an electronic retrieval system—without prior written permission of the copyright owner.

Software derived from copyrighted NetApp material is subject to the following license and disclaimer:

THIS SOFTWARE IS PROVIDED BY NETAPP “AS IS” AND WITHOUT ANY EXPRESS OR IMPLIED WARRANTIES, INCLUDING, BUT NOT LIMITED TO, THE IMPLIED WARRANTIES OF MERCHANTABILITY AND FITNESS FOR A PARTICULAR PURPOSE, WHICH ARE HEREBY DISCLAIMED. IN NO EVENT SHALL NETAPP BE LIABLE FOR ANY DIRECT, INDIRECT, INCIDENTAL, SPECIAL, EXEMPLARY, OR CONSEQUENTIAL DAMAGES (INCLUDING, BUT NOT LIMITED TO, PROCUREMENT OF SUBSTITUTE GOODS OR SERVICES; LOSS OF USE, DATA, OR PROFITS; OR BUSINESS INTERRUPTION) HOWEVER CAUSED AND ON ANY THEORY OF LIABILITY, WHETHER IN CONTRACT, STRICT LIABILITY, OR TORT (INCLUDING NEGLIGENCE OR OTHERWISE) ARISING IN ANY WAY OUT OF THE USE OF THIS SOFTWARE, EVEN IF ADVISED OF THE POSSIBILITY OF SUCH DAMAGE.

NetApp reserves the right to change any products described herein at any time, and without notice. NetApp assumes no responsibility or liability arising from the use of products described herein, except as expressly agreed to in writing by NetApp. The use or purchase of this product does not convey a license under any patent rights, trademark rights, or any other intellectual property rights of NetApp.

The product described in this manual may be protected by one or more U.S. patents, foreign patents, or pending applications.

LIMITED RIGHTS LEGEND: Use, duplication, or disclosure by the government is subject to restrictions as set forth in subparagraph (b)(3) of the Rights in Technical Data -Noncommercial Items at DFARS 252.227-7013 (FEB 2014) and FAR 52.227-19 (DEC 2007).

Data contained herein pertains to a commercial product and/or commercial service (as defined in FAR 2.101) and is proprietary to NetApp, Inc. All NetApp technical data and computer software provided under this Agreement is commercial in nature and developed solely at private expense. The U.S. Government has a non-exclusive, non-transferrable, nonsublicensable, worldwide, limited irrevocable license to use the Data only in connection with and in support of the U.S. Government contract under which the Data was delivered. Except as provided herein, the Data may not be used, disclosed, reproduced, modified, performed, or displayed without the prior written approval of NetApp, Inc. United States Government license rights for the Department of Defense are limited to those rights identified in DFARS clause 252.227-7015(b) (FEB 2014).

Trademark information

NETAPP, the NETAPP logo, and the marks listed at <http://www.netapp.com/TM> are trademarks of NetApp, Inc. Other company and product names may be trademarks of their respective owners.