



Install and setup

ONTAP Systems

NetApp
January 19, 2022

Table of Contents

- Install and setup 1
 - Start here: Choose your installation and setup experience 1
 - Quick steps - AFF A700 and FAS9000 1
 - Video steps - AFF A700 and FAS9000 1
 - Detailed guide - AFF A700 and FAS9000 2

Install and setup

Start here: Choose your installation and setup experience

For most configurations, you can choose from different content formats.

- [Quick steps](#)

A printable PDF of step-by-step instructions with live links to additional content.

- [Video steps](#)

Video step-by-step instructions.

- [Detailed steps](#)

Online step-by-step instructions with live links to additional content.

For MetroCluster configurations, see either:

- [Install MetroCluster IP configuration](#)
- [Install MetroCluster Fabric-Attached configuration](#)

Quick steps - AFF A700 and FAS9000

This guide gives graphic instructions for a typical installation of your system from racking and cabling, through initial system bring-up. Use this guide if you are familiar with installing NetApp systems.

Access the *Installation and Setup Instructions* PDF poster:

[AFF A700 Installation and Setup Instructions](#)

[FAS9000 Installation and Setup Instructions](#)

Video steps - AFF A700 and FAS9000

There are two videos; one showing how to rack and cable your system and one showing an example of using the System Manager Guided Setup to perform initial system configuration.

Video one of two: Hardware installation and cabling

The following video shows how to install and cable your new system.

[Installation and setup of an AFF A700 or FAS9000](#)

Video two of two: Performing end-to-end software configuration

The following video shows end-to-end software configuration for systems running ONTAP 9.2 and later.

[NetApp video: Software configuration for vSphere NAS datastores for FAS/AFF systems running ONTAP 9.2](#)

Detailed guide - AFF A700 and FAS9000

This guide gives detailed step-by-step instructions for installing a typical NetApp system. Use this guide if you want more detailed installation instructions.

Step 1: Prepare for installation

To install your system, you need to create an account on the NetApp Support Site, register your system, and get license keys. You also need to inventory the appropriate number and type of cables for your system and collect specific network information.

Before you begin

You need to have access to the Hardware Universe for information about site requirements as well as additional information on your configured system. You might also want to have access to the Release Notes for your version of ONTAP for more information about this system.

[NetApp Hardware Universe](#)

[Find the Release Notes for your version of ONTAP 9](#)

You need to provide the following at your site:

- Rack space for the storage system
- Phillips #2 screwdriver
- Additional networking cables to connect your system to your network switch and laptop or console with a Web browser

Steps









1. Unpack the contents of all boxes.
2. Record the system serial number from the controllers.



3. Inventory and make a note of the number and types of cables you received.

The following table identifies the types of cables you might receive. If you receive a cable not listed in the table, see the Hardware Universe to locate the cable and identify its use.

[NetApp Hardware Universe](#)

Type of cable...	Part number and length	Connector type	For...
10 GbE network cable	X6566B-2-R6, (112-00299), 2m X6566B-3-R6, 112-00300, 3m X6566B-5-R6 , 112-00301, 5m		Network cable
40 GbE network cable 40 GbE cluster interconnect	X66100-1,112-00542, 1m X66100-3,112-00543, 3m		40 GbE network Cluster interconnect
100 GbE network cable 100 GbE storage cable	X66211A-05 (112-00595), 0.5m X66211A-1 (112-00573), 1m X66211A-2 (112-00574), 2m X66211A-5 (112-00574), 5m		Network cable Storage cable  This cable applies to AFF A700 only.
Optical network cables (order dependent)	X6553-R6 (112-00188), 2m X6536-R6 (112-00090), 5m		FC host network
Cat 6, RJ-45 (order dependent)	Part numbers X6585-R6 (112-00291), 3m X6562-R6 (112-00196), 5m		Management network and Ethernet data
Storage	X66031A (112-00436), 1m X66032A (112-00437), 2m X66033A (112-00438), 3m		Storage
Micro-USB console cable	Not applicable		Console connection during software setup on non-Windows or Mac laptop/console
Power cables	Not applicable		Powering up the system

4. Review the *NetApp ONTAP Configuration Guide* and collect the required information listed in that guide.

[ONTAP Configuration Guide](#)

Step 2: Install the hardware

You need to install your system in a 4-post rack or NetApp system cabinet, as applicable.

Steps

1. Install the rail kits, as needed.
2. Install and secure your system using the instructions included with the rail kit.



You need to be aware of the safety concerns associated with the weight of the system.

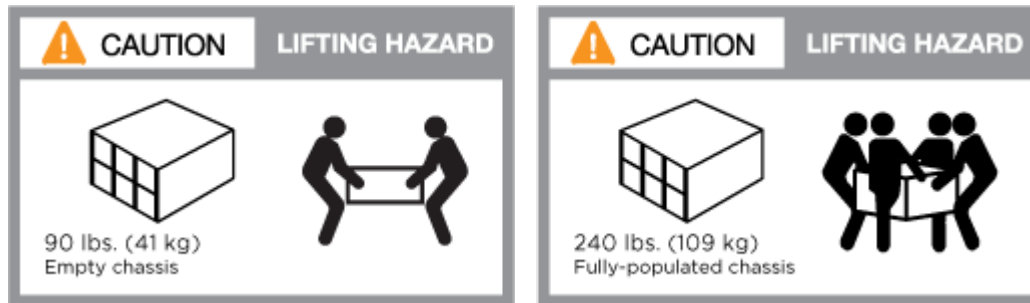

The label on the left indicates an empty chassis, while the label on the right indicates a fully-populated system.

1. Attach cable management devices (as shown).

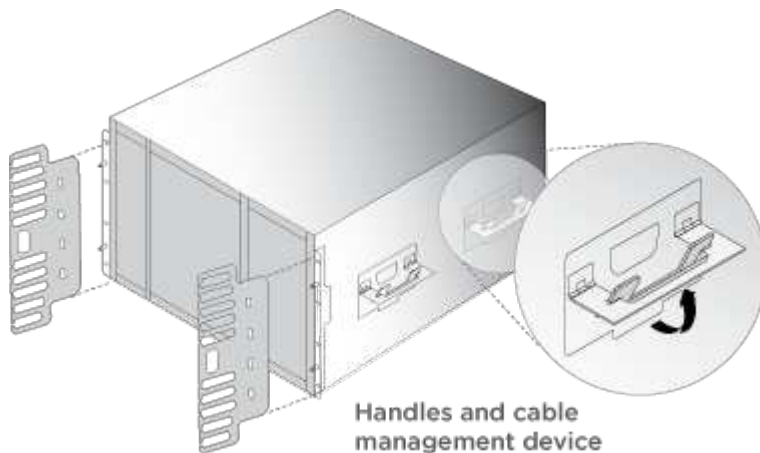

2. Place the bezel on the front of the system.

Step 3: Cable controllers to your network

You can cable the controllers to your network by using the two-node switchless cluster method or by using the cluster interconnect network.

Option 1: Two-node switchless cluster

Management network, data network, and management ports on the controllers are connected to switches. The cluster interconnect ports are cabled on both controllers.

You must have contacted your network administrator for information about connecting the system to the switches.

Be sure to check the direction of the cable pull-tabs when inserting the cables in the ports. Cable pull-tabs are up for all networking module ports.

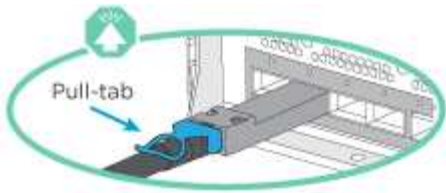

As you insert the connector, you should feel it click into place; if you do not feel it click, remove it, turn it around and try again.

Steps

1. Use the animation or illustration to complete the cabling between the controllers and to the switches:

Cabling a two-node switchless cluster

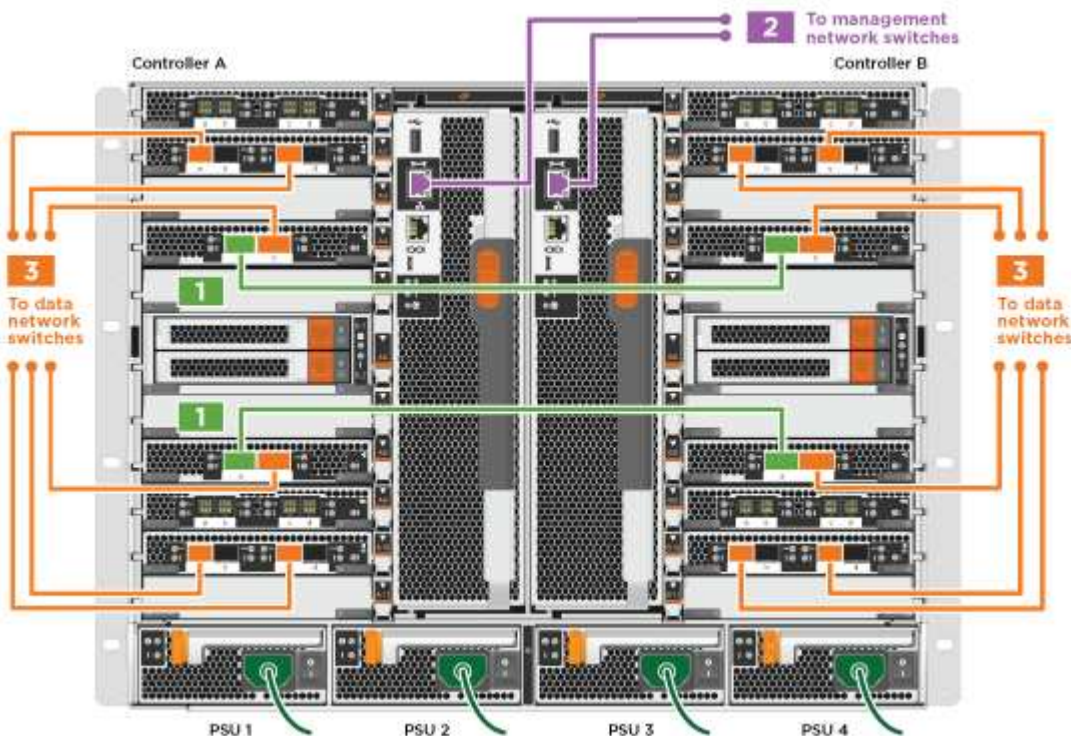

1. Go to [Step 4: Cable controllers to drive shelves](#) for drive shelf cabling instructions.

Option 2: Switched cluster

Management network, data network, and management ports on the controllers are connected to switches. The cluster interconnect and HA ports are cabled on to the cluster/HA switch.

You must have contacted your network administrator for information about connecting the system to the switches.

Be sure to check the direction of the cable pull-tabs when inserting the cables in the ports. Cable pull-tabs are up for all networking module ports.

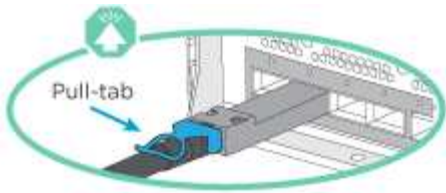

As you insert the connector, you should feel it click into place; if you do not feel it click, remove it, turn it around and try again.

Steps

1. Use the animation or illustration to complete the cabling between the controllers and to the switches:

Switched cluster cabling

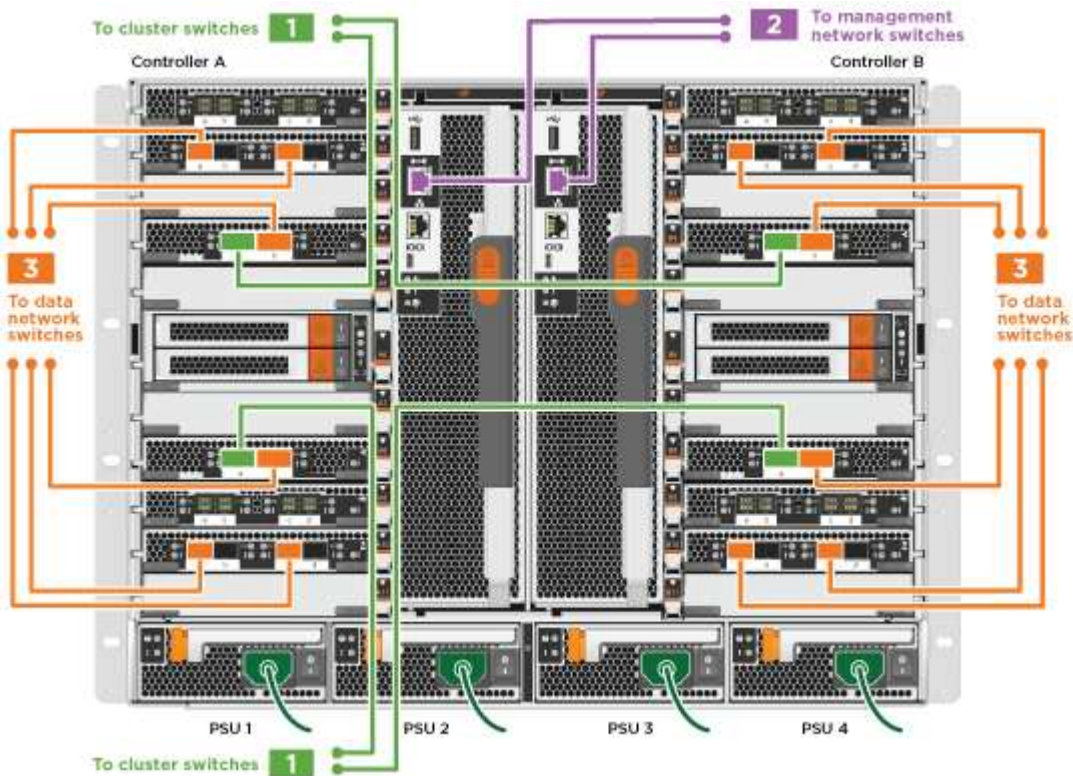

1. Go to [Step 4: Cable controllers to drive shelves](#) for drive shelf cabling instructions.

Step 4: Cable controllers to drive shelves

You can cable your new system to DS212C, DS224C, or NS224 shelves, depending on if it is an AFF or FAS system.

Option 1: Cable the controllers to DS212C or DS224C drive shelves

You must cable the shelf-to-shelf connections, and then cable both controllers to the DS212C or DS224C drive shelves.

The cables are inserted into the drive shelf with the pull-tabs facing down, while the other end of the cable is inserted into the controller storage modules with the pull-tabs up.

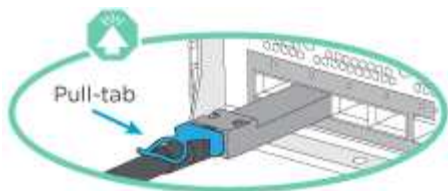
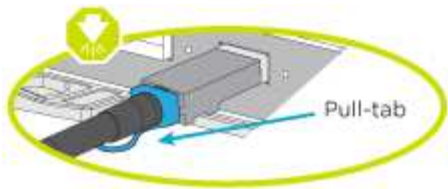

Steps

1. Use the following animations or illustrations to cable your drive shelves to your controllers.



The examples use DS224C shelves. Cabling is similar with other supported SAS drive shelves.

- Cabling SAS shelves in FAS9000, AFF A700, and ASA AFF A700, ONTAP 9.7 and earlier:

[Cabling SAS storage - ONTAP 9.7 and earlier](#)

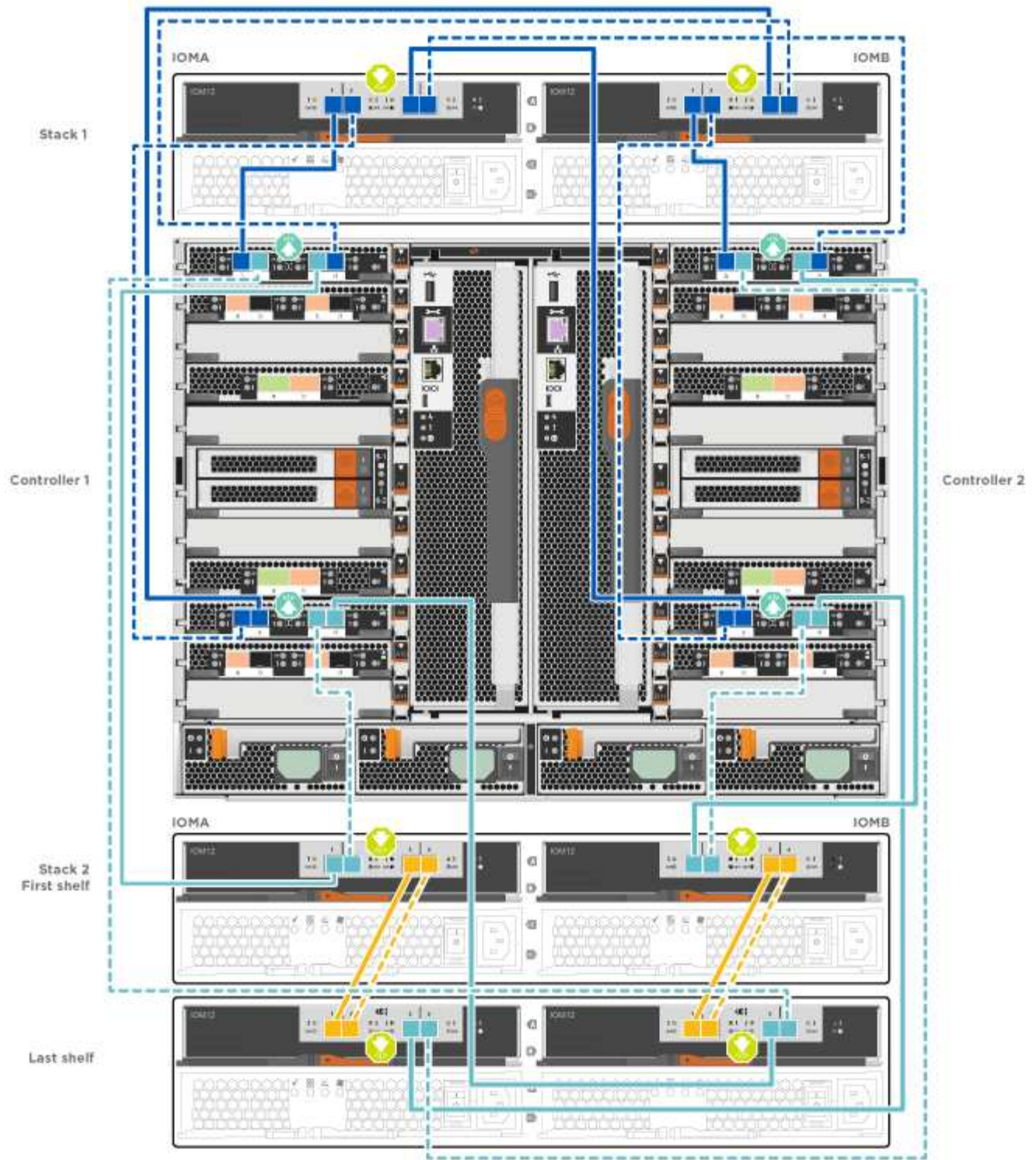

◦ Cabling SAS shelves in FAS9000, AFF A700, and ASA AFF A700, ONTAP 9.8 and later:
[Cabling SAS storage - ONTAP 9.8 and later](#)

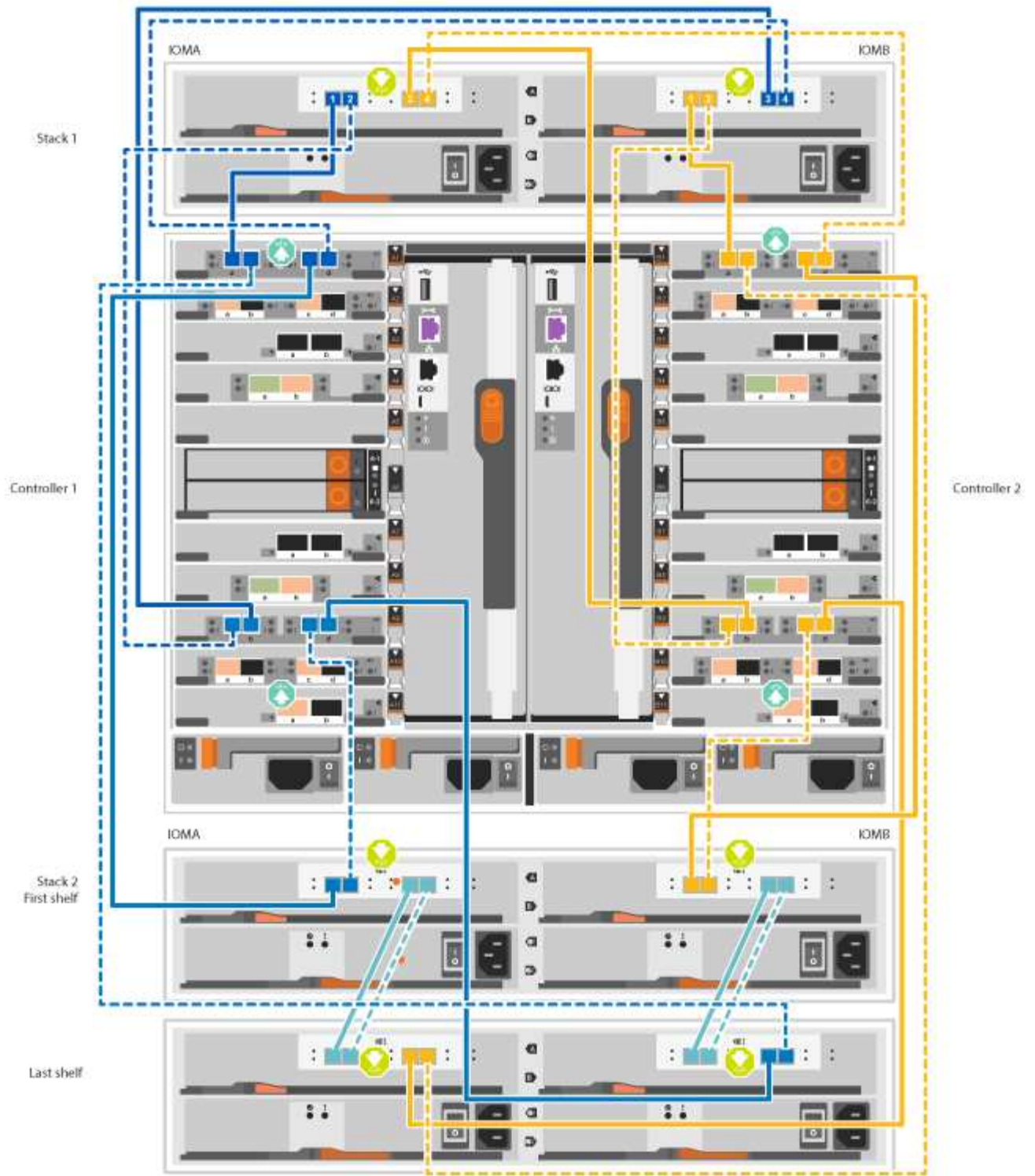

If you have more than one drive shelf stack, see the *Installation and Cabling Guide* for your drive shelf type.

[Install and cable shelves for a new system installation - shelves with IOM12 modules](#)

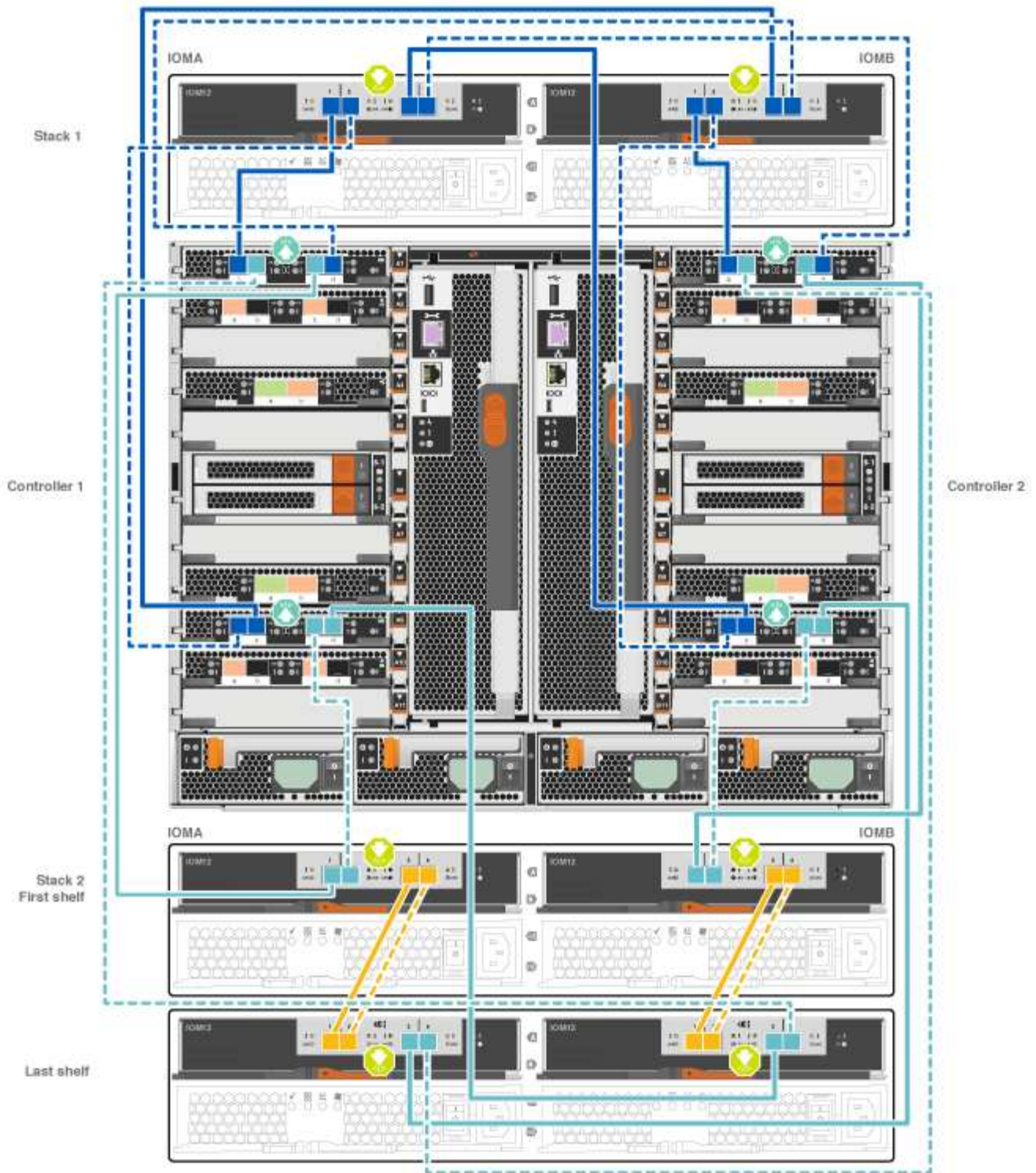

2. Go to [Step 5: Complete system setup and configuration](#) to complete system setup and configuration.

Option 2: Cable the controllers to a single NS224 drive shelf in AFF A700 and ASA AFF A700 systems running ONTAP 9.8 and later only

You must cable each controller to the NSM modules on the NS224 drive shelf on an AFF A700 or ASA AFF A700 running system ONTAP 9.8 or later.

- This task applies to AFF A700 and ASA AFF A700 running ONTAP 9.8 or later only.

- The systems must have at least one X91148A module installed in slots 3 and/or 7 for each controller. The animation or illustrations show this module installed in both slots 3 and 7.
- Be sure to check the illustration arrow for the proper cable connector pull-tab orientation. The cable pull-tab for the storage modules are up, while the pull tabs on the shelves are down.

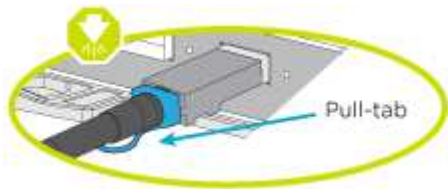
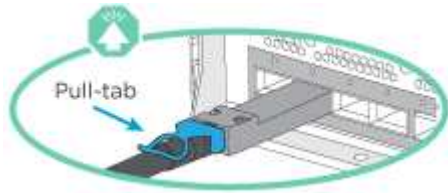

As you insert the connector, you should feel it click into place; if you do not feel it click, remove it, turn it around and try again.

Steps

1. Use the following animation or illustrations to cable your controllers with two X91148A storage modules to a single NS224 drive shelf, or use the diagram to cable your controllers with one X91148A storage module to a single NS224 drive shelf.

Cabling a single NS224 shelf - ONTAP 9.8 and later

AFF A700 HA pair with one NS224 shelf

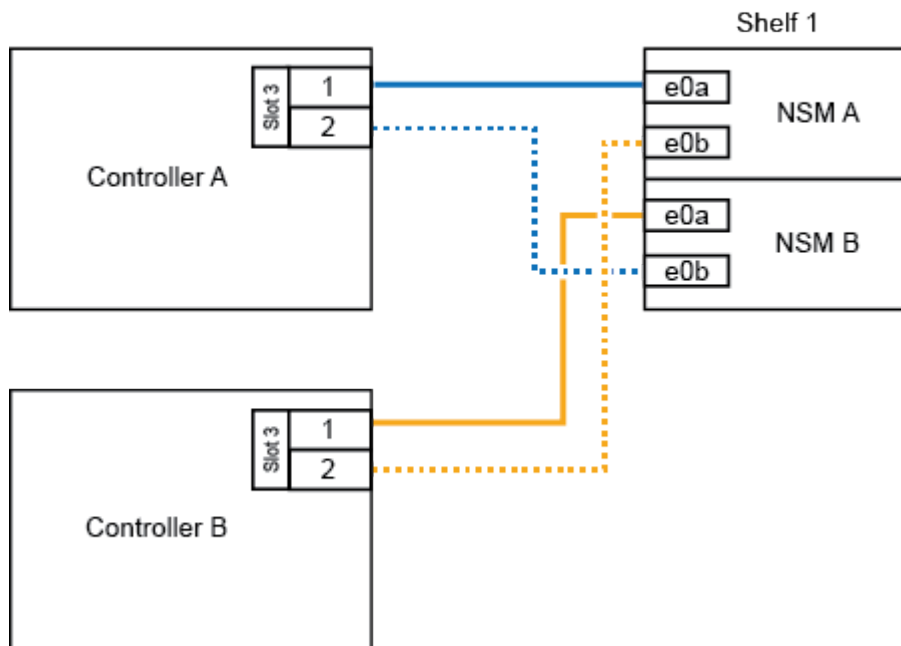

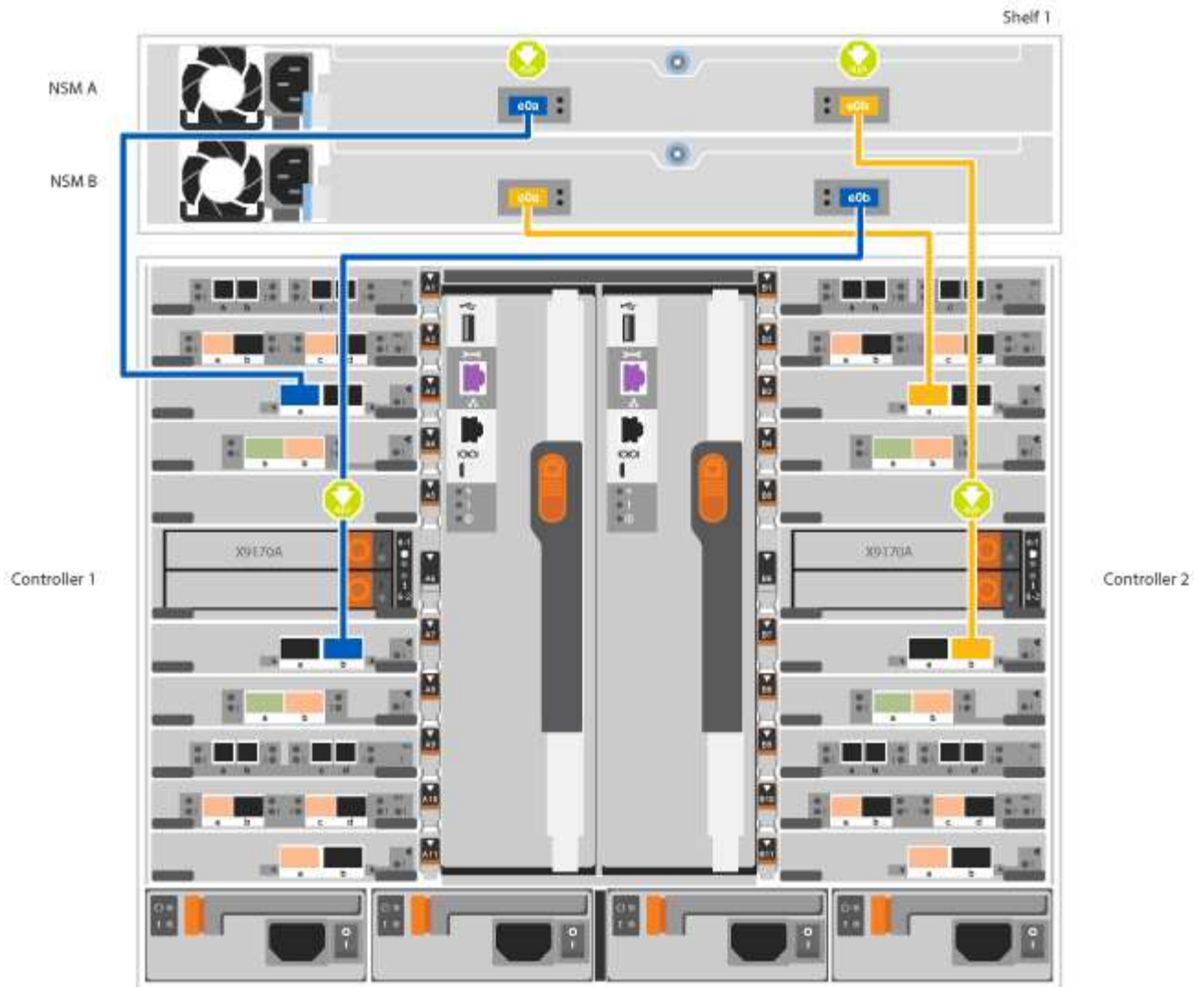

2. Go to [Step 5: Complete system setup and configuration](#) to complete system setup and configuration.

Option 3: Cable the controllers to two NS224 drive shelves in AFF A700 and ASA AFF A700 systems running ONTAP 9.8 and later only

You must cable each controller to the NSM modules on the NS224 drive shelves on an AFF A700 or ASA AFF A700 running system ONTAP 9.8 or later.

- This task applies to AFF A700 and ASA AFF A700 running ONTAP 9.8 or later only.
- The systems must have two X91148A modules, per controller, installed in slots 3 and 7.
- Be sure to check the illustration arrow for the proper cable connector pull-tab orientation. The cable pull-tab for the storage modules are up, while the pull tabs on the shelves are down.

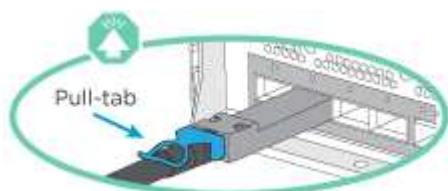

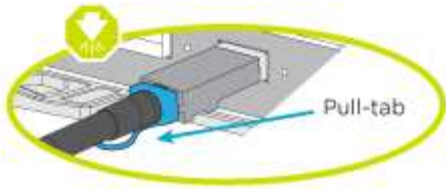

As you insert the connector, you should feel it click into place; if you do not feel it click, remove it, turn it around and try again.

Steps

1. Use the following animation or illustrations to cable your controllers to two NS224 drive shelves.

Cabling two NS224 shelves - ONTAP 9.8 and later

AFF A700 HA pair with two NS224 shelves

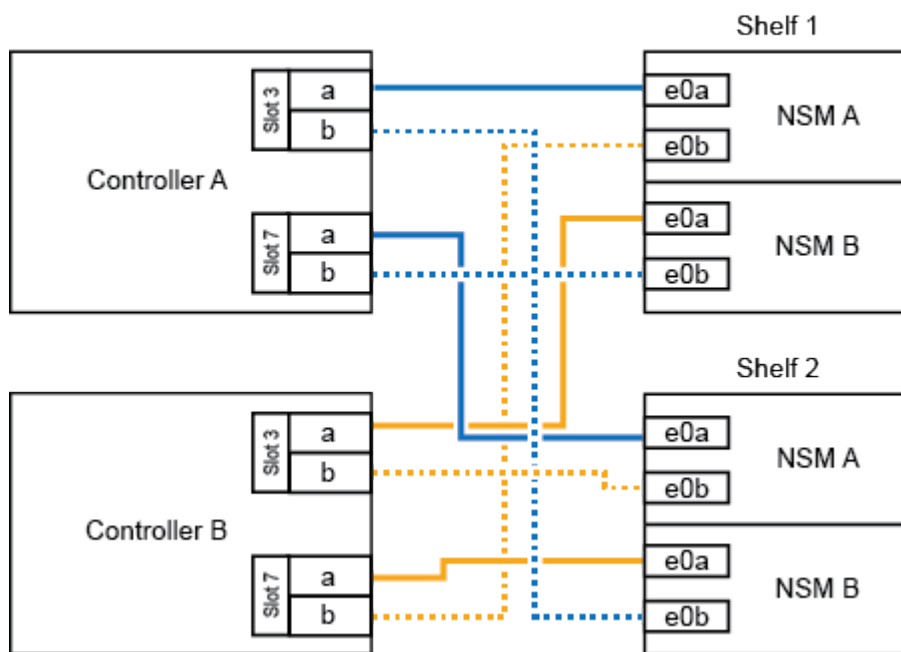

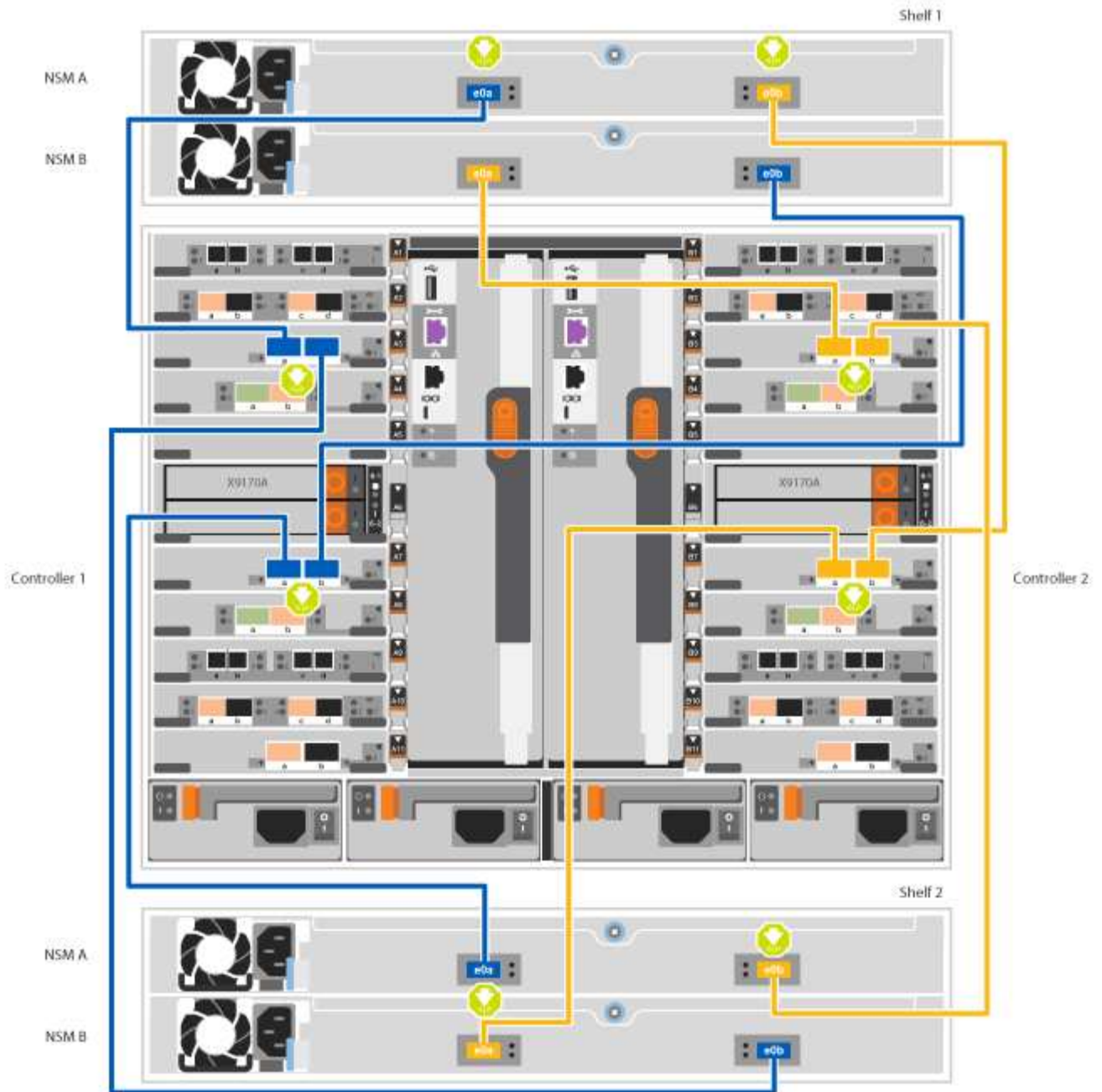

2. Go to [Step 5: Complete system setup and configuration](#) to complete system setup and configuration.

Step 5: Complete system setup and configuration

You can complete the system setup and configuration using cluster discovery with only a connection to the switch and laptop, or by connecting directly to a controller in the system and then connecting to the management switch.

Option 1: Completing system setup and configuration if network discovery is enabled

If you have network discovery enabled on your laptop, you can complete system setup and configuration using automatic cluster discovery.

Steps

1. Use the following animation to set one or more drive shelf IDs:

If your system has NS224 drive shelves, the shelves are pre-set to shelf ID 00 and 01. If you want to change the shelf IDs, you must create a tool to insert into the hole where button is located.

Setting SAS or NVMe drive shelf IDs

2. Plug the power cords into the controller power supplies, and then connect them to power sources on different circuits.
3. Turn on the power switches to both nodes.

Turn on the power to the controllers

 Initial booting may take up to eight minutes.

4. Make sure that your laptop has network discovery enabled.

See your laptop's online help for more information.

5. Use the following animation to connect your laptop to the Management switch.

Connecting your laptop to the Management switch

6. Select an ONTAP icon listed to discover:

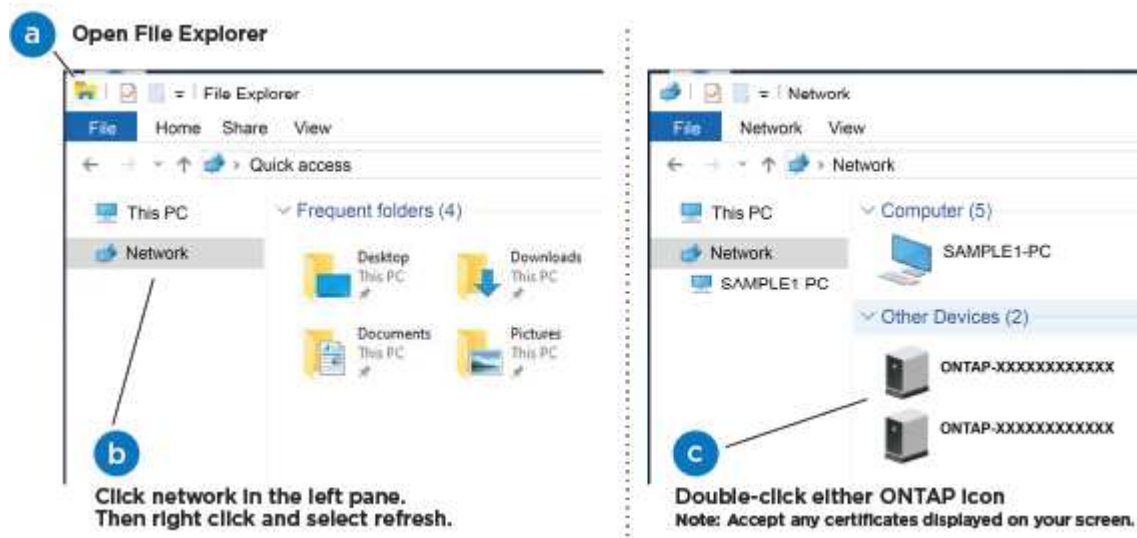

- a. Open File Explorer.
- b. Click network in the left pane.
- c. Right click and select refresh.
- d. Double-click either ONTAP icon and accept any certificates displayed on your screen.

 XXXXX is the system serial number for the target node.

System Manager opens.

7. Use System Manager guided setup to configure your system using the data you collected in the *NetApp*

8. Set up your account and download Active IQ Config Advisor:

- a. Log in to your existing account or create an account.

[NetApp Support Registration](#)

- b. Register your system.

[NetApp Product Registration](#)

- c. Download Active IQ Config Advisor.

[NetApp Downloads: Config Advisor](#)

9. Verify the health of your system by running Config Advisor.

10. After you have completed the initial configuration, go to the [ONTAP & ONTAP System Manager Documentation Resources](#) page for information about configuring additional features in ONTAP.

Option 2: Completing system setup and configuration if network discovery is not enabled

If network discovery is not enabled on your laptop, you must complete the configuration and setup using this task.

Steps

1. Cable and configure your laptop or console:

- a. Set the console port on the laptop or console to 115,200 baud with N-8-1.



See your laptop or console's online help for how to configure the console port.

- b. Connect the console cable to the laptop or console using the console cable that came with your system, and then connect the laptop to the management switch on the management subnet .

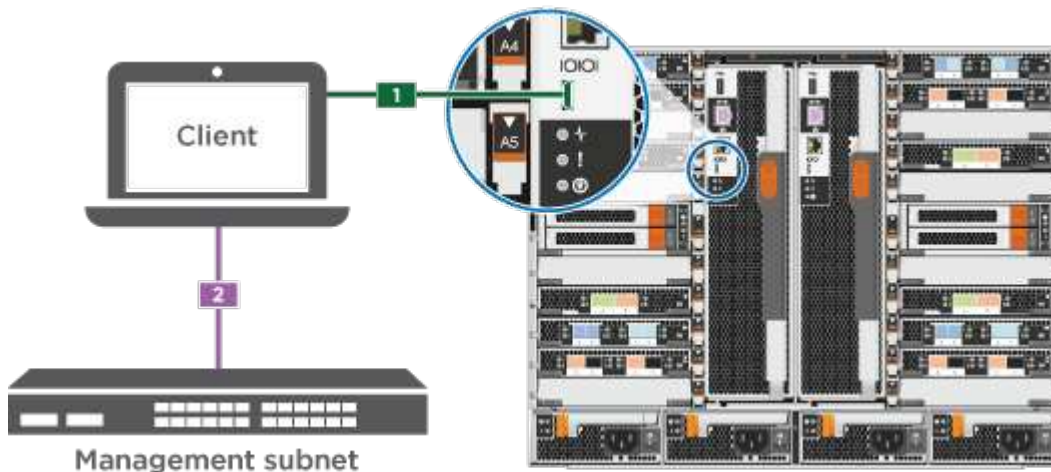

- c. Assign a TCP/IP address to the laptop or console, using one that is on the management subnet.

2. Use the following animation to set one or more drive shelf IDs:

If your system has NS224 drive shelves, the shelves are pre-set to shelf ID 00 and 01. If you want to change the shelf IDs, you must create a tool to insert into the hole where button is located.

Setting SAS or NVMe drive shelf IDs

3. Plug the power cords into the controller power supplies, and then connect them to power sources on different circuits.
4. Turn on the power switches to both nodes.

Turn on the power to the controllers



Initial booting may take up to eight minutes.

5. Assign an initial node management IP address to one of the nodes.

If the management network has DHCP...	Then...
Configured	Record the IP address assigned to the new controllers.
Not configured	<ol style="list-style-type: none">a. Open a console session using PuTTY, a terminal server, or the equivalent for your environment.  Check your laptop or console's online help if you do not know how to configure PuTTY.b. Enter the management IP address when prompted by the script.

6. Using System Manager on your laptop or console, configure your cluster:
 - a. Point your browser to the node management IP address.



The format for the address is https://x.x.x.x.

- b. Configure the system using the data you collected in the *NetApp ONTAP Configuration guide*.

ONTAP Configuration Guide

7. Set up your account and download Active IQ Config Advisor:
 - a. Log in to your existing account or create an account.

NetApp Support Registration

- b. Register your system.

NetApp Product Registration

- c. Download Active IQ Config Advisor.

NetApp Downloads: Config Advisor

8. Verify the health of your system by running Config Advisor.

9. After you have completed the initial configuration, go to the [ONTAP & ONTAP System Manager Documentation Resources](#) page for information about configuring additional features in ONTAP.

Copyright Information

Copyright © 2022 NetApp, Inc. All rights reserved. Printed in the U.S. No part of this document covered by copyright may be reproduced in any form or by any means-graphic, electronic, or mechanical, including photocopying, recording, taping, or storage in an electronic retrieval system- without prior written permission of the copyright owner.

Software derived from copyrighted NetApp material is subject to the following license and disclaimer:

THIS SOFTWARE IS PROVIDED BY NETAPP "AS IS" AND WITHOUT ANY EXPRESS OR IMPLIED WARRANTIES, INCLUDING, BUT NOT LIMITED TO, THE IMPLIED WARRANTIES OF MERCHANTABILITY AND FITNESS FOR A PARTICULAR PURPOSE, WHICH ARE HEREBY DISCLAIMED. IN NO EVENT SHALL NETAPP BE LIABLE FOR ANY DIRECT, INDIRECT, INCIDENTAL, SPECIAL, EXEMPLARY, OR CONSEQUENTIAL DAMAGES (INCLUDING, BUT NOT LIMITED TO, PROCUREMENT OF SUBSTITUTE GOODS OR SERVICES; LOSS OF USE, DATA, OR PROFITS; OR BUSINESS INTERRUPTION) HOWEVER CAUSED AND ON ANY THEORY OF LIABILITY, WHETHER IN CONTRACT, STRICT LIABILITY, OR TORT (INCLUDING NEGLIGENCE OR OTHERWISE) ARISING IN ANY WAY OUT OF THE USE OF THIS SOFTWARE, EVEN IF ADVISED OF THE POSSIBILITY OF SUCH DAMAGE.

NetApp reserves the right to change any products described herein at any time, and without notice. NetApp assumes no responsibility or liability arising from the use of products described herein, except as expressly agreed to in writing by NetApp. The use or purchase of this product does not convey a license under any patent rights, trademark rights, or any other intellectual property rights of NetApp.

The product described in this manual may be protected by one or more U.S. patents, foreign patents, or pending applications.

RESTRICTED RIGHTS LEGEND: Use, duplication, or disclosure by the government is subject to restrictions as set forth in subparagraph (c)(1)(ii) of the Rights in Technical Data and Computer Software clause at DFARS 252.277-7103 (October 1988) and FAR 52-227-19 (June 1987).

Trademark Information

NETAPP, the NETAPP logo, and the marks listed at <http://www.netapp.com/TM> are trademarks of NetApp, Inc. Other company and product names may be trademarks of their respective owners.