



Install and setup

ONTAP Systems

NetApp
May 18, 2022

Table of Contents

- Install and setup 1
 - Start here: Choose your installation and setup experience 1
 - Quick steps - AFF A900 1
 - Video steps - AFF A900 1
 - Detailed steps - AFF 900 2

Install and setup

Start here: Choose your installation and setup experience

You can choose from different content formats to guide you through installing and setting up your new storage system.

- [Quick steps](#)

A printable PDF of step-by-step instructions with live links to additional content.

- [Video steps](#)

Video step-by-step instructions.

- [Detailed steps](#)

Online step-by-step instructions with live links to additional content.

Quick steps - AFF A900

This topic gives graphic instructions for a typical installation of your system from racking and cabling, through initial system bring-up. Use this content if you are familiar with installing NetApp systems.

Access the *Installation and Setup Instructions* PDF poster:

[AFF A900 Installation and Setup Instructions](#)

Video steps - AFF A900

There are two videos; one showing how to rack and cable your system and one showing an example of using the System Manager Guided Setup to perform initial system configuration.

Video one of two: Hardware installation and cabling

The following video shows how to install and cable your new system.

[Animation—AFF A900 Installation and setup instructions](#)

Video two of two: Performing end-to-end software configuration

The following video shows end-to-end software configuration for systems running ONTAP 9.2 and later.

[NetApp video: Software configuration for vSphere NAS datastores for FAS/AFF systems running ONTAP 9.2](#)

Detailed steps - AFF 900

This article gives detailed step-by-step instructions for installing a typical NetApp system. Use this article if you want more detailed installation instructions.

Step 1: Prepare for installation

To install your system, you need to create an account on the NetApp Support Site, register your system, and get license keys. You also need to inventory the appropriate number and type of cables for your system and collect specific network information.

Before you begin

You need to have access to the [NetApp Hardware Universe](#) for information about site requirements as well as additional information on your configured system.

You might also want to have access to the [ONTAP 9 Release Notes](#) for your version of ONTAP for more information about this system.

You need to provide the following at your site:

- Rack space for the storage system
- Phillips #2 screwdriver
- Additional networking cables to connect your system to your network switch and laptop or console with a Web browser

Steps

1. Unpack the contents of all boxes.
2. Record the system serial number from the controllers.









3. Inventory and make a note of the number and types of cables you received.

The following table identifies the types of cables you might receive. If you receive a cable not listed in the table, see the Hardware Universe to locate the cable and identify its use.

[NetApp Hardware Universe](#)

Type of cable...	Part number and length	Connector type	For...
25 GbE data Cable	X66240A-05 (112-00639), 0.5m X66240A-2 (112-00598), 2m X66240A-5 (112-00600), 5m		Network cable

Type of cable...	Part number and length	Connector type	For...
32 Gb FC (SFP+ Op)	X66250-2 (112-00342), 2m X66250-5 (112-00344), 5m X66250-15 (112-00346), 15m		FC optical network cable
40 GbE network cable	X66100-1 (112-00542), 1m X66100-3 (112-00543), 3m X66100-5 (112-00544), 5m		Ethernet data, cluster network
100 GbE cable	X66211B-1 (112-00573), 1m X66211B-2 (112-00574), 2m X66211B-5 (112-00576), 5m		Network, NVME storage, Ethernet data, cluster network
Optical cables	X66031A (112-00436), 1m X66032A (112-00437), 2m X66033A (112-00438), 3m		FC optical network
Cat 6, RJ-45 (order dependent)	Part numbers X6585-R6 (112-00291), 3m X6562-R6 (112-00196), 5m		Management network and Ethernet data
Micro-USB console cable	Not applicable		Console connection during software setup on non-Windows or Mac laptop/console
Power cables	Not applicable		Powering up the system

4. Review the [ONTAP Configuration Guide](#) and collect the required information listed in that guide.

Step 2: Install the hardware

You need to install your system in a 4-post rack or NetApp system cabinet, as applicable.

1. Install the rail kits, as needed.
2. Install and secure your system using the instructions included with the rail kit.



You need to be aware of the safety concerns associated with the weight of the system.

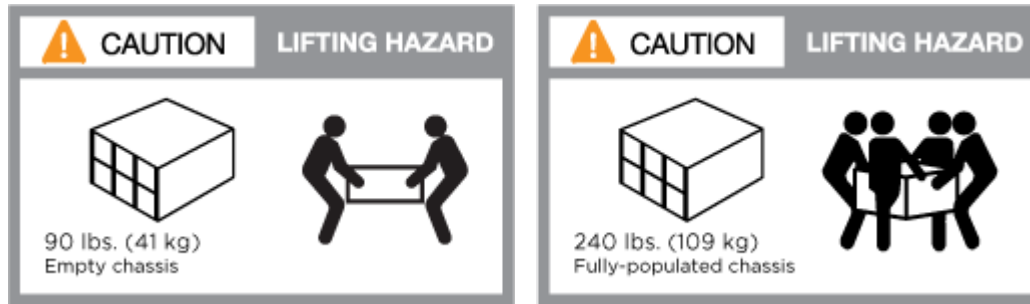

3. Attach cable management devices (as shown).

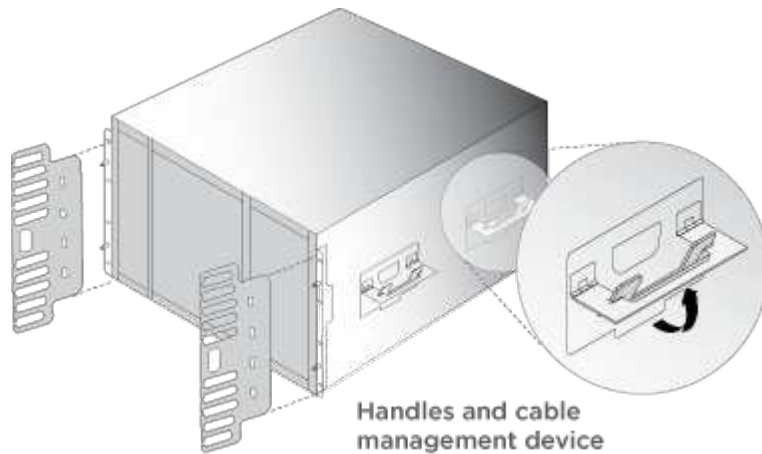

4. Place the bezel on the front of the system.

Step 3: Cable controllers to your network

You can cable the controllers to your network by using the two-node switchless cluster method or by using the cluster interconnect network.

Option 1: Two-node switchless cluster

Management network, data network, and management ports on the controllers are connected to switches. The cluster interconnect ports are cabled on both controllers.

Before you begin

You must have contacted your network administrator for information about connecting the system to the switches.

Be sure to check the direction of the cable pull-tabs when inserting the cables in the ports. Cable pull-tabs are up for all networking module ports.

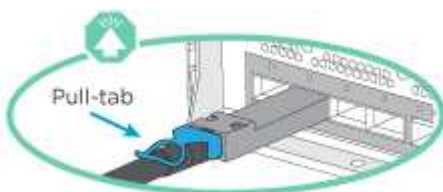







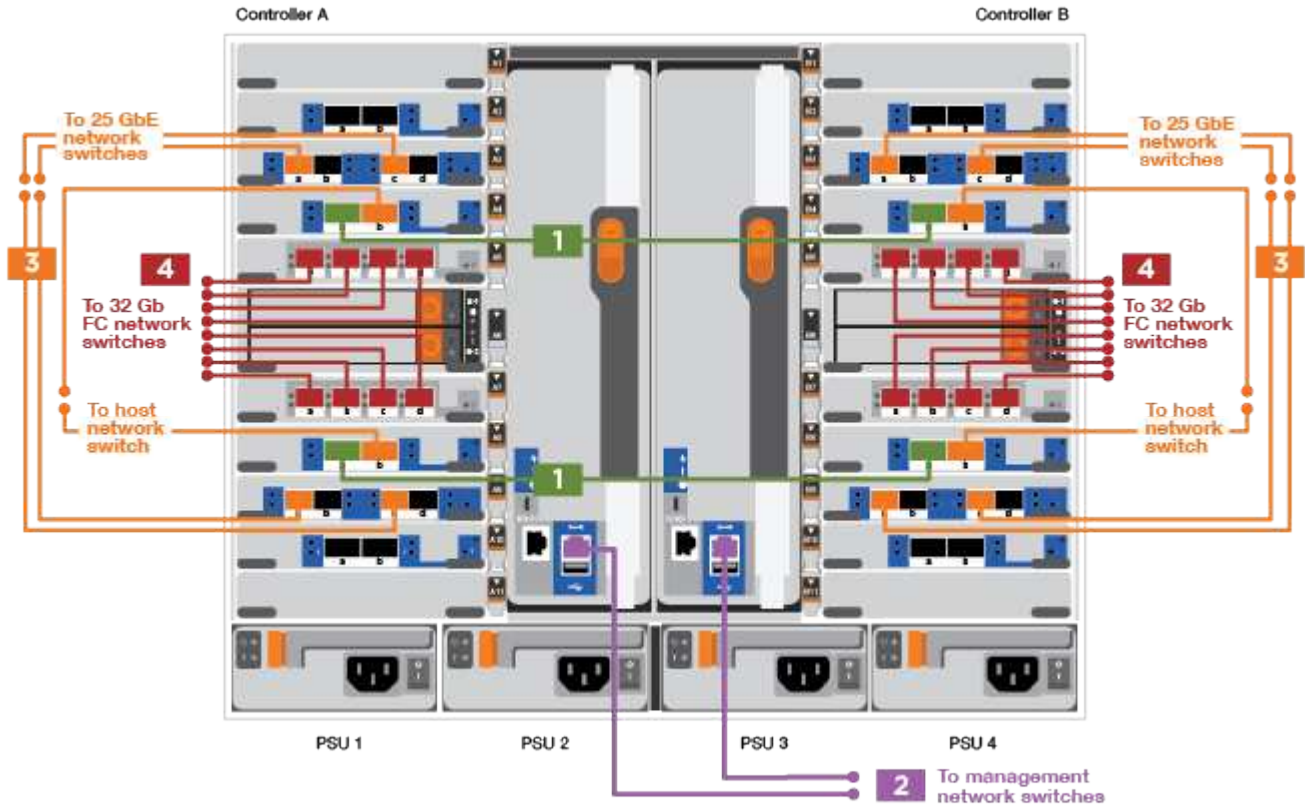

As you insert the connector, you should feel it click into place; if you do not feel it click, remove it, turn it around and try again.

1. Use the animation or illustration to complete the cabling between the controllers and to the switches:

Animation — Cabling a two-node switchless cluster



Step	Perform on each controller
1	Cable cluster interconnect ports: <ul style="list-style-type: none"> • Slot A4 and B4 (e4a) • Slot A8 and B8 (e8a) 
2	Cable controller management (wrench) ports. 

Step	Perform on each controller
<p>3</p>	<p>Cable 25 GbE network switches:</p> <p>Ports in slot A3 and B3 (e3a and e3c) and slot A9 and B9 (e9a and e9c) to the 25 GbE network switches.</p>  <p>40GbE host network switches:</p> <p>Cable host-side b ports in slot A4 and B4 (e4b) and slot A8 and B8 (e8b) to the host switch.</p> 
<p>4</p>	<p>Cable 32 Gb FC connections:</p> <p>Cable ports in slot A5 and B5 (5a, 5b, 5c, and 5d) and slot A7 and B7 (7a, 7b, 7c, and 7d) to the 32 Gb FC network switches.</p> 

2. To cable your storage, see [Step 4: Cable controllers to drive shelves](#).

Option 2: Switched cluster

Management network, data network, and management ports on the controllers are connected to switches. The cluster interconnect and HA ports are cabled on to the cluster/HA switch.

Before you begin

You must have contacted your network administrator for information about connecting the system to the switches.

Be sure to check the direction of the cable pull-tabs when inserting the cables in the ports. Cable pull-tabs are up for all networking module ports.

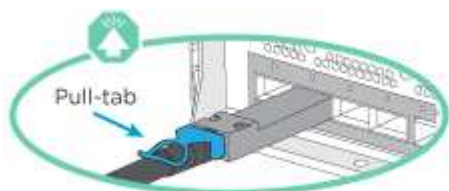



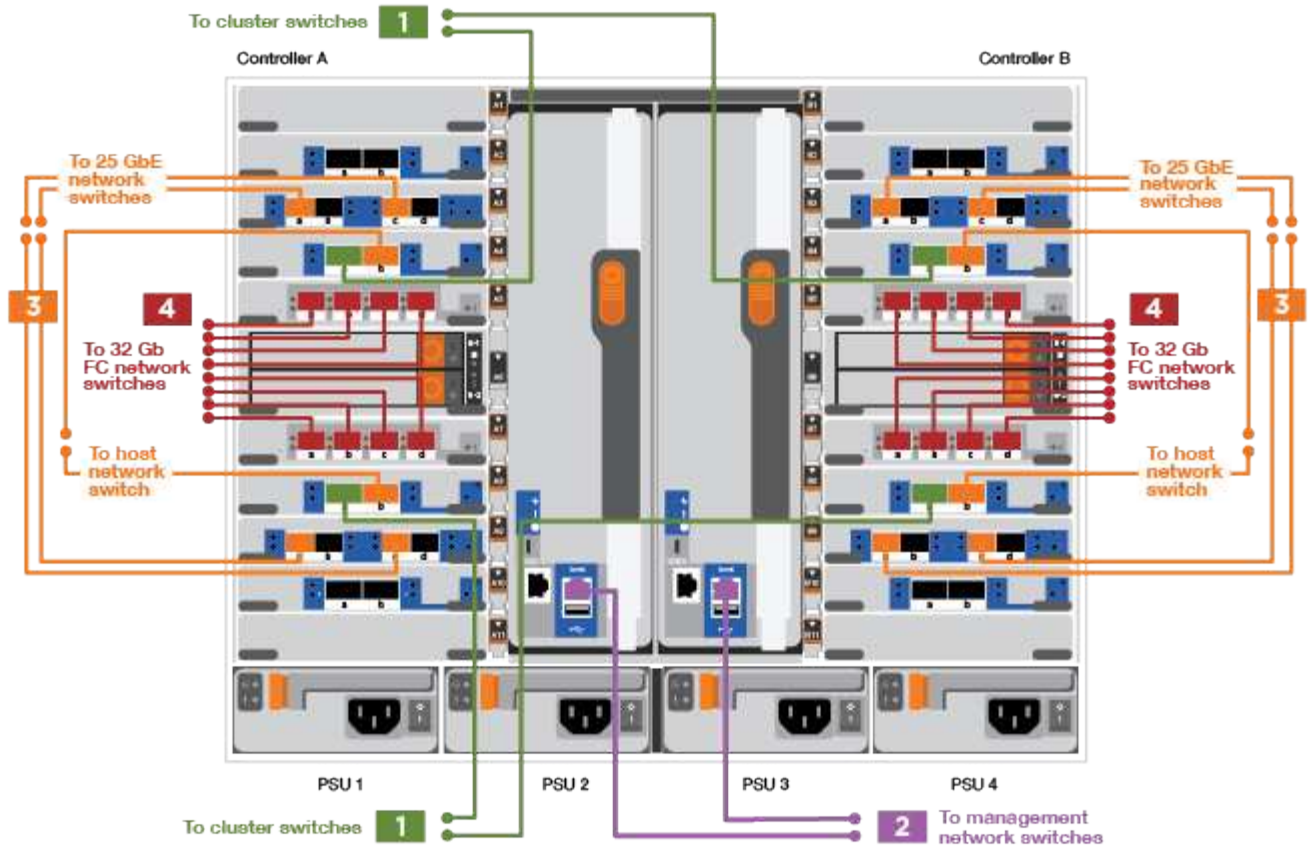

As you insert the connector, you should feel it click into place; if you do not feel it click, remove it, turn it around and try again.

1. Use the animation or illustration to complete the cabling between the controllers and to the switches:

[Animation—Cabling a switched cluster](#)



Step	Perform on each controller
<p>1</p>	<p>Cable cluster interconnect a ports:</p> <ul style="list-style-type: none"> • Slot A4 and B4 (e4a) to the cluster network switch. • Slot A8 and B8 (e8a) to the cluster network switch. 
<p>2</p>	<p>Cable controller management (wrench) ports.</p> 

Step	Perform on each controller
<p>3</p>	<p>Cable 25GbE network switches:</p> <p>Ports in slot A3 and B3 (e3a and e3c) and slot A9 and B9 (e9a and e9c) to the 25 GbE network switches.</p>  <p>40GbE host network switches:</p> <p>Cable host-side b ports in slot A4 and B4 (e4b) and slot A8 and B8 (e8b) to the host switch.</p> 
<p>4</p>	<p>Cable 32 Gb FC connections:</p> <p>Cable ports in slot A5 and B5 (5a, 5b, 5c, and 5d) and slot A7 and B7 (7a, 7b, 7c, and 7d) to the 32 Gb FC network switches.</p> 

2. To cable your storage, see [Step 4: Cable controllers to drive shelves](#).

Step 4: Cable controllers to drive shelves

Option 1: Cable the controllers to a single NS224 drive shelf in AFF A900

You must cable each controller to the NSM modules on the NS224 drive shelf on an AFF A900 system.

Before you begin

- Be sure to check the illustration arrow for the proper cable connector pull-tab orientation. The cable pull-tab for the storage modules are up, while the pull tabs on the shelves are down.

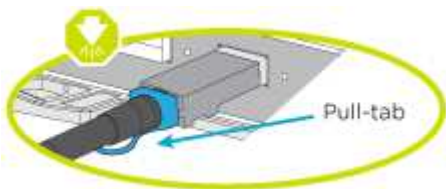
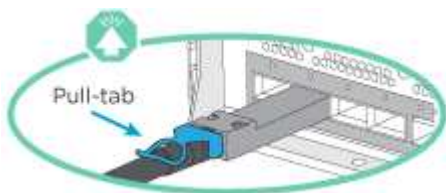





As you insert the connector, you should feel it click into place; if you do not feel it click, remove it, turn it around and try again.

1. Use the following animation or drawings to cable your controllers to a single NS224 drive shelf.

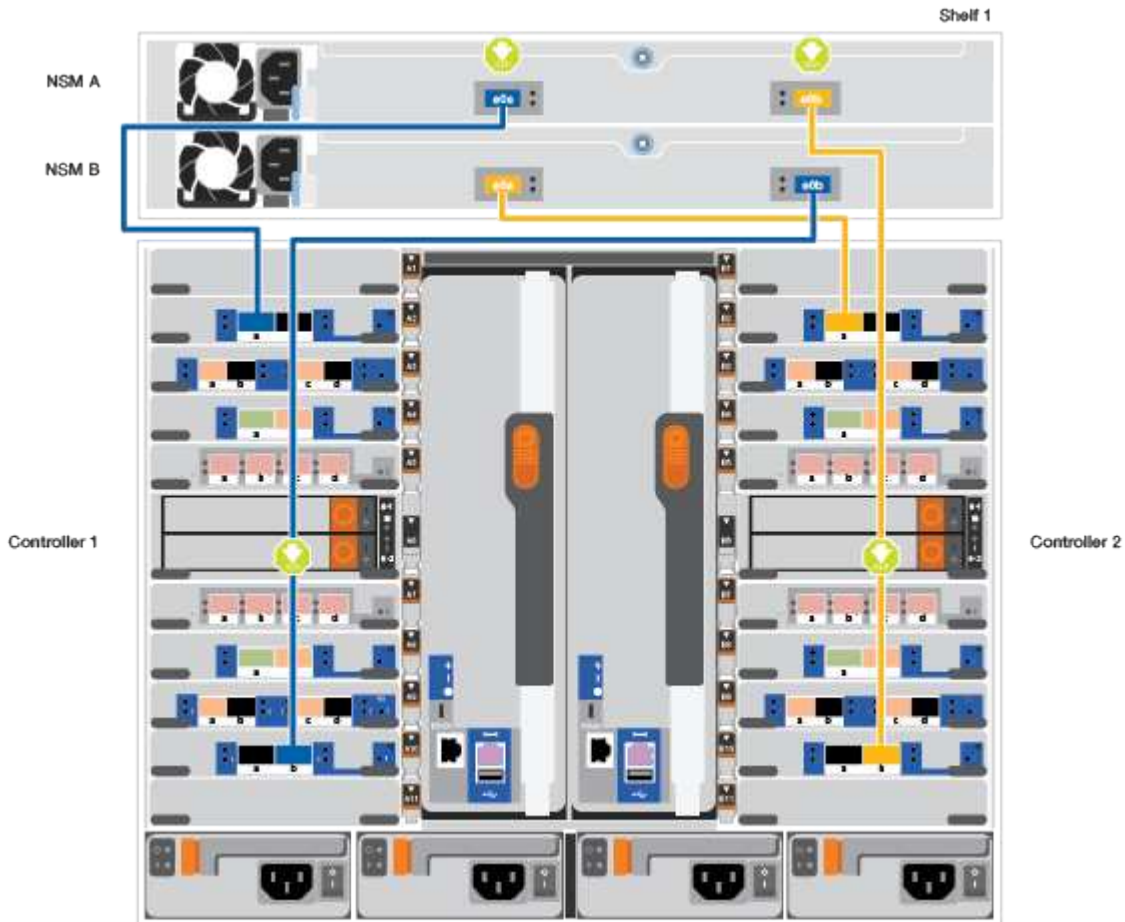
Animation—Cabling a single NS224 shelf



Step	Perform on each controller
1	<ul style="list-style-type: none">• Connect controller A port e2a to port e0a on NSM A on the shelf.• Connect controller A port e10b to port e0b on NSM B on the shelf.  <p>100 GbE cable</p>

Step	Perform on each controller
<p>2</p>	<ul style="list-style-type: none"> • Connect controller B port e2a to port e0a on NSM B on the shelf. • Connect controller B port e10b to port e0b on NSM A on the shelf.  <p>100 GbE cable</p>

2. To complete setting up your system, see [Step 5: Complete system setup and configuration](#).

Option 2: Cable the controllers to two NS224 drive shelves in AFF A900

You must cable each controller to the NSM modules on the NS224 drive shelves.

Before you begin

- Be sure to check the illustration arrow for the proper cable connector pull-tab orientation. The cable pull-tab for the storage modules are up, while the pull tabs on the shelves are down.

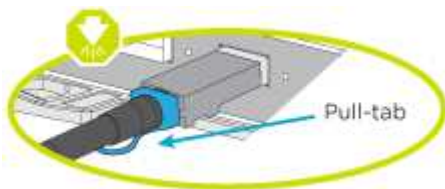
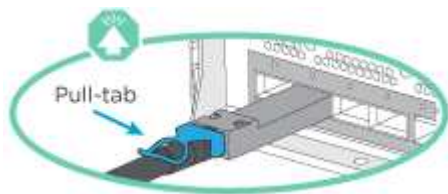



As you insert the connector, you should feel it click into place; if you do not feel it click, remove it, turn it around and try again.

1. Use the following animation or diagram to cable your controllers to two NS224 drive shelves.

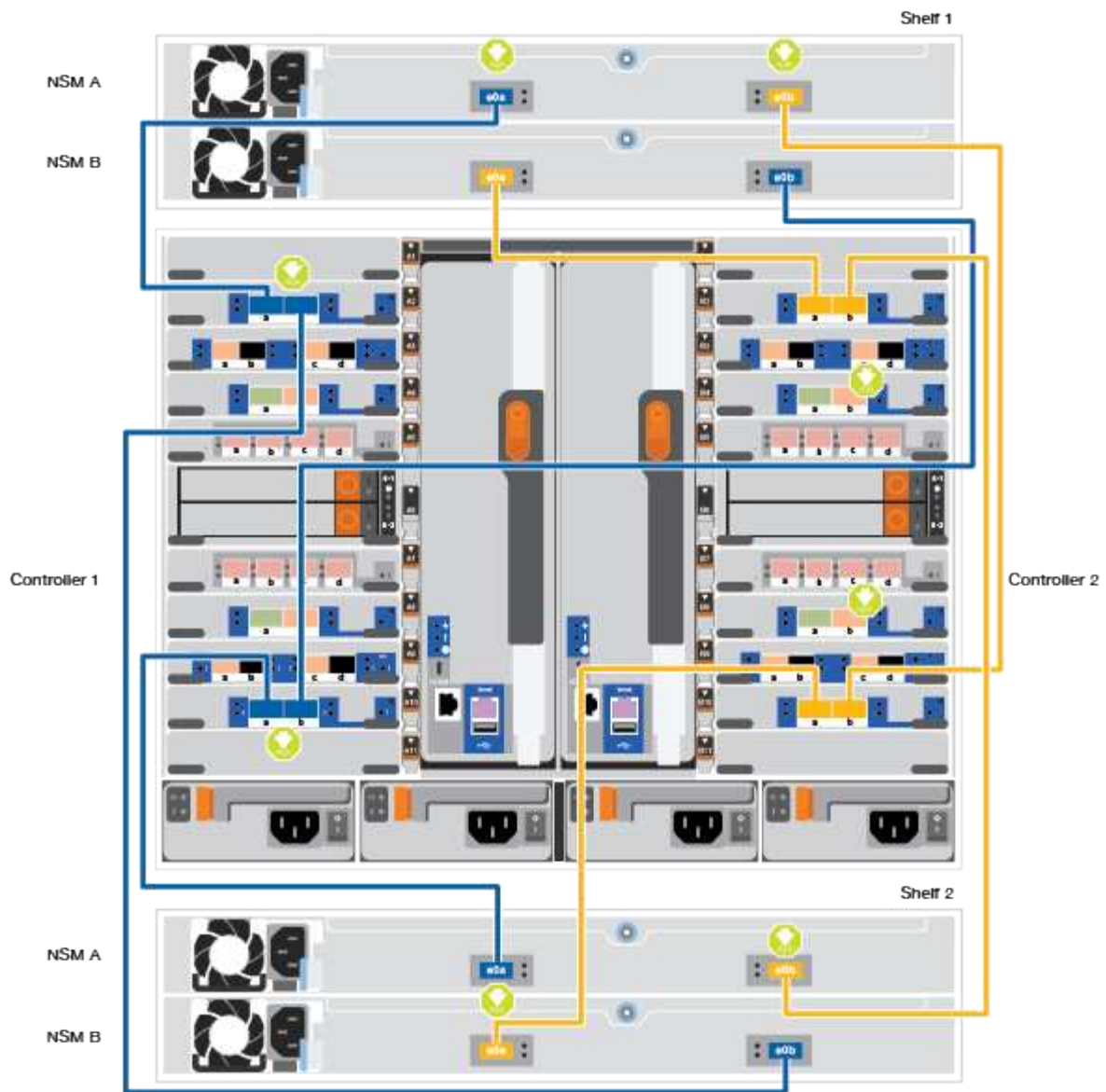
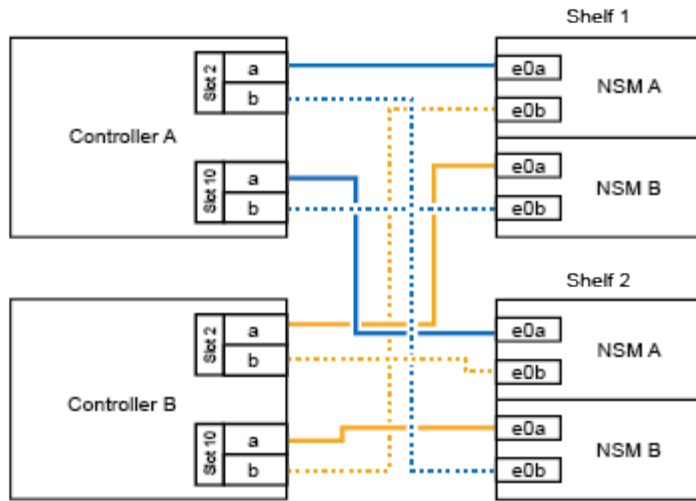
[Animation—Cabling two NS224 shelves](#)



Step	Perform on each controller
<p>1</p>	<ul style="list-style-type: none"> • Connect controller A port e2a to NSM A e0a on shelf 1. • Connect controller A port e10b to NSM B e0b on shelf 1. • Connect controller A port e2b to NSM B e0b on shelf 2. • Connect controller A port e10a to NSM A e0a on shelf 2.  <p>100 GbE cable</p>
<p>2</p>	<ul style="list-style-type: none"> • Connect controller B port e2a to NSM B e0a on shelf 1. • Connect controller B port e10b to NSM A e0b on shelf 1. • Connect controller B port e2b to NSM A e0b on shelf 2. • Connect controller B port e10a to NSM B e0a on shelf 2.  <p>100 GbE cable</p>

2. To complete setting up your system, see [Step 5: Complete system setup and configuration](#).

Step 5: Complete system setup and configuration

You can complete the system setup and configuration using cluster discovery with only a connection to the switch and laptop, or by connecting directly to a controller in the system and then connecting to the management switch.

Option 1: If network discovery is enabled

If you have network discovery enabled on your laptop, you can complete system setup and configuration using automatic cluster discovery.

1. Use the following animation or drawing to set one or more drive shelf IDs:

The NS224 shelves are pre-set to shelf ID 00 and 01. If you want to change the shelf IDs, you must create a tool to insert into the hole where button is located.

[Animation—Setting SAS or NVMe drive shelf IDs](#)

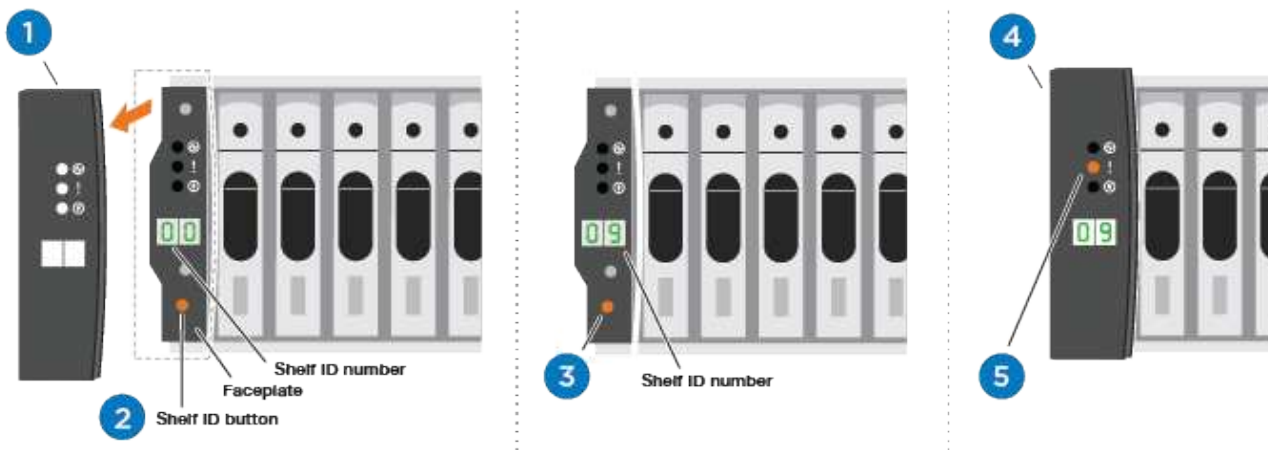

1	Remove the end cap.
2	Press and hold shelf ID button until first digit blinks, then push to advance to 0-9. Note: The first digit continues to blink
3	Press and hold shelf ID button until second digit blinks, then push to advance to 0-9. Note: The first digit stops blinking, and the second digit continues to blink.
4	Replace the end cap.
5	Wait 10 seconds for the Amber LED (!) to appear, then power-cycle the drive shelf to set shelf ID.

2. Plug the power cords into the controller power supplies, and then connect them to power sources on different circuits.
3. Turn on the power switches to both nodes.

Animation—Turn on the power to the controllers

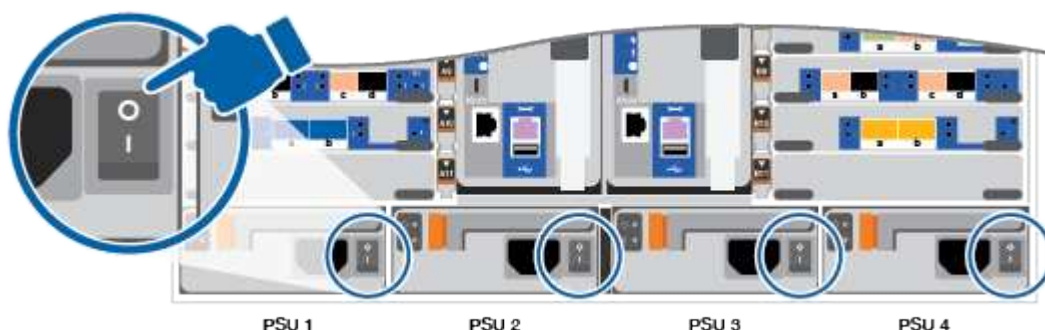

i Initial booting may take up to eight minutes.

4. Make sure that your laptop has network discovery enabled.

See your laptop's online help for more information.

5. Use the following animation to connect your laptop to the Management switch.

[Animation—Connecting your laptop to the Management switch](#)



6. Select an ONTAP icon listed to discover:

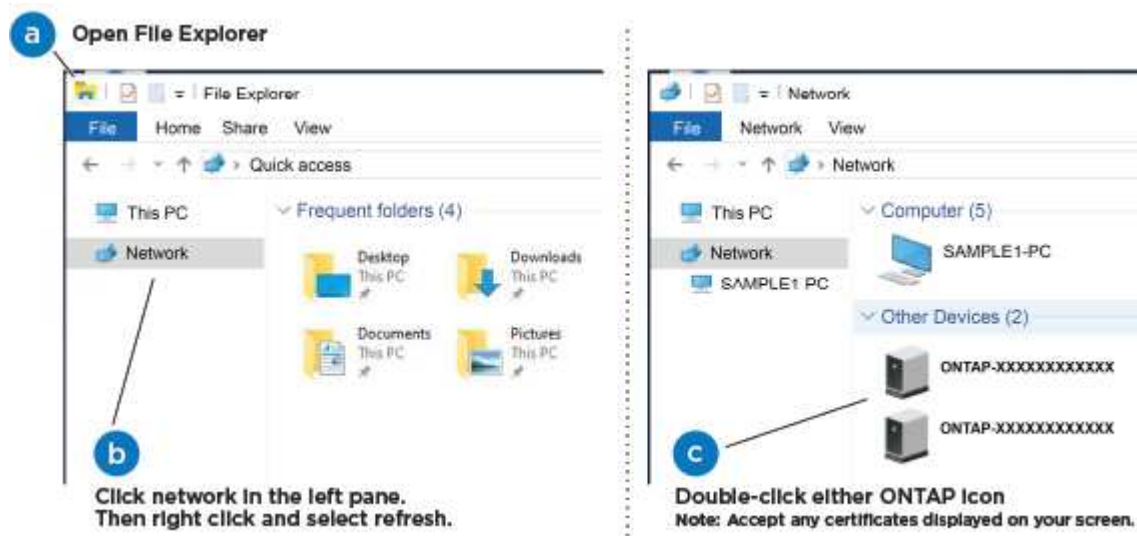

- a. Open File Explorer.
- b. Click network in the left pane.
- c. Right click and select refresh.
- d. Double-click either ONTAP icon and accept any certificates displayed on your screen.



XXXXX is the system serial number for the target node.

System Manager opens.

7. Use System Manager guided setup to configure your system using the data you collected in the [ONTAP Configuration Guide](#).
8. Set up your account and download Active IQ Config Advisor:
 - a. Log in to your existing account or create an account.

[NetApp Support Registration](#)

- b. Register your system.

[NetApp Product Registration](#)

- c. Download Active IQ Config Advisor.

[NetApp Downloads: Config Advisor](#)

9. Verify the health of your system by running Config Advisor.

10. After you have completed the initial configuration, go to the [ONTAP & ONTAP System Manager Documentation Resources](#) page for information about configuring additional features in ONTAP.

Option 2: If network discovery is not enabled

If you are not using a Windows or Mac-based laptop or console or if auto discovery is not enabled, you must complete the configuration and setup using this task.

1. Cable and configure your laptop or console:

- a. Set the console port on the laptop or console to 115,200 baud with N-8-1.



See your laptop or console's online help for how to configure the console port.

- b. Connect the console cable to the laptop or console using the console cable that came with your system, and then connect the laptop to the management switch on the management subnet.

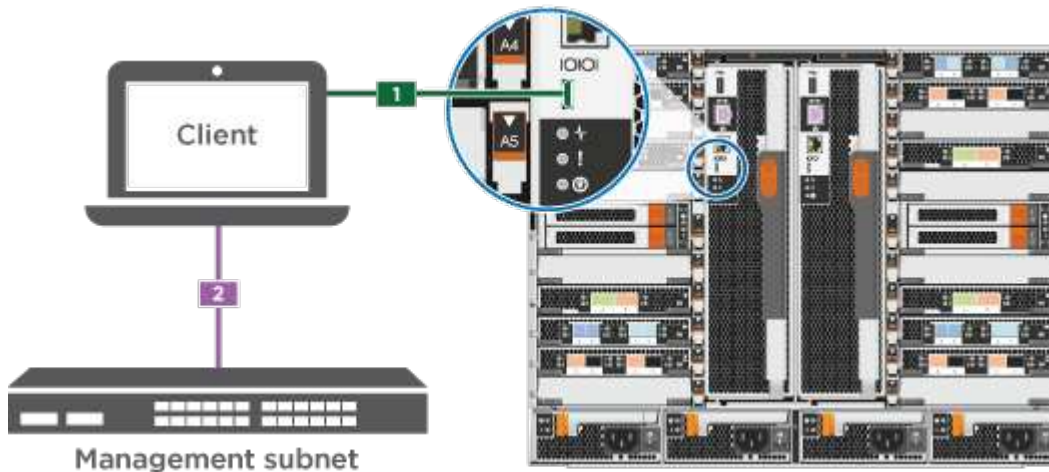

- c. Assign a TCP/IP address to the laptop or console, using one that is on the management subnet.

2. Use the following animation to set one or more drive shelf IDs:

The NS224 shelves are pre-set to shelf ID 00 and 01. If you want to change the shelf IDs, you must create a tool to insert into the hole where button is located.

[Animation—Setting SAS or NVMe drive shelf IDs](#)

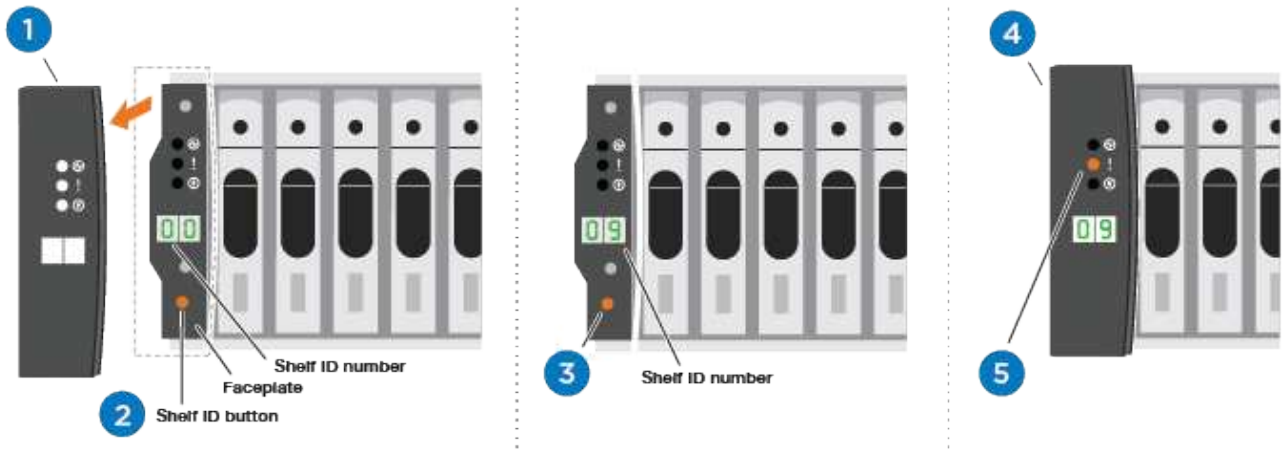

1	Remove the end cap.
2	<p>Press and hold shelf ID button until first digit blinks, then push to advance to 0-9.</p> <p>Note: The first digit continues to blink</p>
3	<p>Press and hold shelf ID button until second digit blinks, then push to advance to 0-9. Note: The first digit stops blinking, and the second digit continues to blink.</p>
4	Replace the end cap.
5	<p>Wait 10 seconds for the Amber LED (!) to appear, then power-cycle the drive shelf to set shelf ID.</p>

3. Plug the power cords into the controller power supplies, and then connect them to power sources on different circuits.
4. Turn on the power switches to both nodes.

[Animation—Turn on the power to the controllers](#)

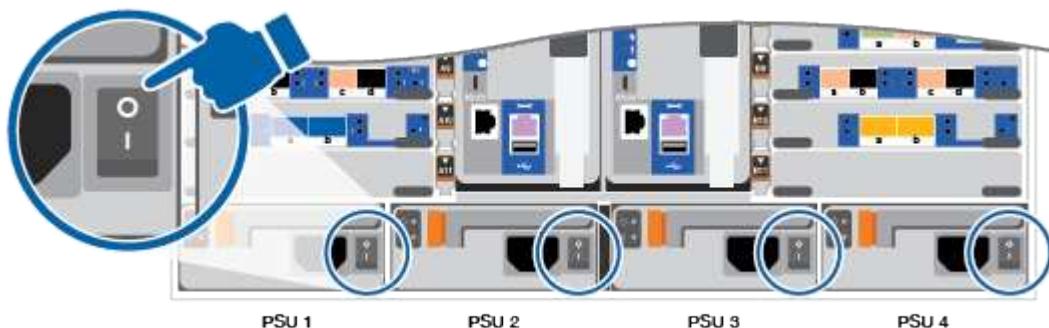

i Initial booting may take up to eight minutes.

1. Assign an initial node management IP address to one of the nodes.

If the management network has DHCP...	Then...
Configured	Record the IP address assigned to the new controllers.
Not configured	<ol style="list-style-type: none">a. Open a console session using PuTTY, a terminal server, or the equivalent for your environment.  Check your laptop or console's online help if you do not know how to configure PuTTY.b. Enter the management IP address when prompted by the script.

2. Using System Manager on your laptop or console, configure your cluster:

- a. Point your browser to the node management IP address.



The format for the address is `https://x.x.x.x`.

- b. Configure the system using the data you collected in the *NetApp ONTAP Configuration guide*.

[ONTAP Configuration Guide](#)

3. Set up your account and download Active IQ Config Advisor:

- a. Log in to your existing account or create an account.

[NetApp Support Registration](#)

- b. Register your system.

[NetApp Product Registration](#)

- c. Download Active IQ Config Advisor.

[NetApp Downloads: Config Advisor](#)

4. Verify the health of your system by running Config Advisor.

5. After you have completed the initial configuration, go to the [ONTAP & ONTAP System Manager Documentation Resources](#) page for information about configuring additional features in ONTAP.

Copyright Information

Copyright © 2022 NetApp, Inc. All rights reserved. Printed in the U.S. No part of this document covered by copyright may be reproduced in any form or by any means-graphic, electronic, or mechanical, including photocopying, recording, taping, or storage in an electronic retrieval system- without prior written permission of the copyright owner.

Software derived from copyrighted NetApp material is subject to the following license and disclaimer:

THIS SOFTWARE IS PROVIDED BY NETAPP "AS IS" AND WITHOUT ANY EXPRESS OR IMPLIED WARRANTIES, INCLUDING, BUT NOT LIMITED TO, THE IMPLIED WARRANTIES OF MERCHANTABILITY AND FITNESS FOR A PARTICULAR PURPOSE, WHICH ARE HEREBY DISCLAIMED. IN NO EVENT SHALL NETAPP BE LIABLE FOR ANY DIRECT, INDIRECT, INCIDENTAL, SPECIAL, EXEMPLARY, OR CONSEQUENTIAL DAMAGES (INCLUDING, BUT NOT LIMITED TO, PROCUREMENT OF SUBSTITUTE GOODS OR SERVICES; LOSS OF USE, DATA, OR PROFITS; OR BUSINESS INTERRUPTION) HOWEVER CAUSED AND ON ANY THEORY OF LIABILITY, WHETHER IN CONTRACT, STRICT LIABILITY, OR TORT (INCLUDING NEGLIGENCE OR OTHERWISE) ARISING IN ANY WAY OUT OF THE USE OF THIS SOFTWARE, EVEN IF ADVISED OF THE POSSIBILITY OF SUCH DAMAGE.

NetApp reserves the right to change any products described herein at any time, and without notice. NetApp assumes no responsibility or liability arising from the use of products described herein, except as expressly agreed to in writing by NetApp. The use or purchase of this product does not convey a license under any patent rights, trademark rights, or any other intellectual property rights of NetApp.

The product described in this manual may be protected by one or more U.S. patents, foreign patents, or pending applications.

RESTRICTED RIGHTS LEGEND: Use, duplication, or disclosure by the government is subject to restrictions as set forth in subparagraph (c)(1)(ii) of the Rights in Technical Data and Computer Software clause at DFARS 252.277-7103 (October 1988) and FAR 52-227-19 (June 1987).

Trademark Information

NETAPP, the NETAPP logo, and the marks listed at <http://www.netapp.com/TM> are trademarks of NetApp, Inc. Other company and product names may be trademarks of their respective owners.